

COASTAL COLLECTION | METAL

BAY METAL	CCM 2 - 3
MARINA METAL	CCM 4 - 5
MARINA UPHOLSTERED ARM WITH METAL LEGS	CCM 6 - 7
REEF UPHOLSTERED ARM WITH METAL LEGS	CCM 8 - 9
SEASIDE LOUNGE	CCM 10 - 12
TIDE METAL	CCM 13 - 15
TIDE METAL SYSTEM SEATING & TABLES	CCM 16 - 17
TIDE METAL SYSTEM SPECIFICATIONS	CCM 18
TIDE FOOTSTOOLS	CCM 19
TIDE REPLACEMENT COMPONENTS/COVERS	CCM 20
COASTAL METAL BENCHES	CCM 21
COASTAL METAL TABLES	CCM 22 - 23



# COASTAL COLLECTION METAL | BAY METAL



## BAY METAL - WALL SAVER DESIGN

POWDER COATED STEEL

	MODEL	STYLE	YARDS	COM	M	COL O	P	R	S	T	U	W/WL
<b>CHAIR - 22" SW</b> W: 22 D: 29.25 H: 36.5 SW: 22 SD: 19 SH: 19 BH: 20	<b>CBAYML-1-22</b>	Tapered	2.75	1533	1635	1759	1871	1992	2111	2232	2350	2529
	<b>CBAYMLS-1-22</b>	Straight	2.75	1533	1635	1759	1871	1992	2111	2232	2350	2529



<b>CHAIR - 27" SW</b> W: 27 SW: 27	<b>CBAYML-1-27</b>	Tapered	4	1710	1858	2038	2202	2378	2550	2726	2898	3158
	<b>CBAYMLS-1-27</b>	Straight	4	1710	1858	2038	2202	2378	2550	2726	2898	3158



<b>CHAIR - 32" SW</b> W: 32 SW: 32	<b>CBAYML-1-32</b>	Tapered	4	1979	2127	2307	2471	2647	2819	2995	3167	3427
	<b>CBAYMLS-1-32</b>	Straight	4	1979	2127	2307	2471	2647	2819	2995	3167	3427



<b>CHAIR - 42" SW</b> W: 42 SW: 42	<b>CBAYML-1-42</b>	Tapered	4.5	2364	2531	2733	2918	3116	3309	3507	3701	3993
	<b>CBAYMLS-1-42</b>	Straight	4.5	2364	2531	2733	2918	3116	3309	3507	3701	3993



<b>SETTEE</b> W: 44 SW: 44	<b>CBAYMLS-2</b>	Straight	5.5	2680	2884	3131	3357	3599	3835	4077	4314	4671
	<b>NOTE: (2) 22"sw Straight Units</b>											



<b>SOFA</b> W: 66 SW: 66	<b>CBAYMLS-3</b>	Straight	8.25	3828	4133	4505	4843	5206	5561	5924	6278	6815
	<b>NOTE: (3) 22"sw Straight Units</b>											



Tapered Seat Unit



Straight Seat Unit



Unique one-piece Seat/Back with Cove Wipe-Out Design

## BAY METAL | LEG OPTIONS

	MODEL	DESCRIPTION	PRICE
<b>METAL LEGS</b>	<b>MM4L</b>	Wall Saver. Specify Powder Coat.	No Upcharge



	MODEL	DESCRIPTION	PRICE
<b>5" HEAVY DUTY CASTERS</b>	<b>5C1</b>	Not Wall Saver. Set of 4 Locking Casters.	20 LIST



**NOTE: Recommended for use with 22", 27", 32"sw only.**

**Casters and tablet can be specified on 27"sw and wider. NOT recommended on 22"sw. 20 lbs of counterweight must be added for stability on 27"sw. Add \$228 List.**



Powder Coat selection required for metal legs and tablet post.

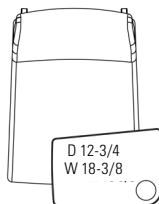
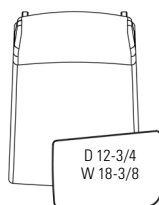

With Cup Holder option

CHOOSE POSITION

(4)

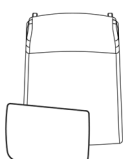

(4) - Tablet on right as seated

(5)

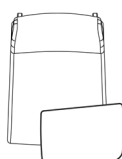

(5) - Tablet on left as seated

SOLID SURFACE TABLET OPTION

MODEL	GRADE	A	B	C	D
ST-(4/5)	Stocked	887 LIST	925 LIST	983 LIST	1073 LIST
	Non-stocked (per color, per order)	ADD 410 NET	450 NET	490 NET	520 NET

LAMINATE OVER PLYWOOD CORE/EDGE TABLET OPTION

MODEL	GRADE	PRICE
LT-(4/5)	Stocked (Laminate tablets have a plywood edge. Specify finish.)	695 LIST
	Non-stocked (per color, per order)	ADD 50 NET

VENEER OVER PLYWOOD CORE/EDGE TABLET OPTION

MODEL	GRADE	PRICE
VT-(4/5)	Standard Wood Finish	695 LIST
	Custom Finish (one time charge per color)	ADD 300 NET

CUP HOLDER

MODEL	FINISH	PRICE
CUPIN	Brushed Aluminum	236 LIST

NOTE: When specified with legs and tablet on 22" and 27"sw, 20 lbs of counterweight must be added for stability. Add \$228 List.

Tablets are NOT available on 22"sw WITH casters.

RECESSED PULL HANDLE



MODEL	DESCRIPTION	PRICE
RPH(B/G)	For use with Casters option. Specify Black (B) or Gray (G).	94 LIST

SECURE BOTTOM COVERS



MODEL	SEAT WIDTH	PRICE
SBC	22"	182 LIST
	27"	193 LIST
	32"	193 LIST
	42"	219 LIST

NOTE: Secure Bottom Covers include tamper-resistant fasteners. Available on individual units only, not on ganged Settee or Sofa.

PRODUCT OPTIONS

- MOISTURE BARRIER \$48 List / Yard; Note: Moisture Barrier may telegraph through thinner textiles.
- FIRE WALL / CA T.B. 133 \$82 List / Yard
- WEIGHTED / THEFT DETERRENT \$333 List / 25 lb Weight  
\$666 List / 50 lb Weight









# COASTAL COLLECTION METAL | MARINA METAL



## MARINA METAL WITH SOLID SURFACE ARM CAPS - WALL SAVER DESIGN

POWDER COATED STEEL

		MODEL	STYLE	YARDS	COM	M	COL O	P	R	S	T	U	W/WL
<b>CHAIR - 22" SW</b> W: 25.5 D: 29.5 H: 36.5 SW: 22 SD: 19 SH: 19 BH: 20 AH: 25.75		<b>CMMAR-1-22</b>	Tapered	2.75	2129	2231	2355	2467	2588	2707	2828	2946	3125
		<b>CMMARS-1-22</b>	Straight	2.75	2129	2231	2355	2467	2588	2707	2828	2946	3125
<b>CHAIR - 27" SW</b> W: 30.5 SW: 27		<b>CMMAR-1-27</b>	Tapered	4	2306	2454	2634	2798	2974	3146	3322	3494	3754
		<b>CMMARS-1-27</b>	Straight	4	2306	2454	2634	2798	2974	3146	3322	3494	3754
<b>CHAIR - 32" SW</b> W: 35.5 SW: 32		<b>CMMAR-1-32</b>	Tapered	4	2575	2723	2903	3067	3243	3415	3591	3763	4023
		<b>CMMARS-1-32</b>	Straight	4	2575	2723	2903	3067	3243	3415	3591	3763	4023
<b>CHAIR - 42" SW</b> W: 45.5 SW: 42		<b>CMMAR-1-42</b>	Tapered	4.5	2960	3127	3329	3514	3712	3905	4103	4297	4589
		<b>CMMARS-1-42</b>	Straight	4.5	2960	3127	3329	3514	3712	3905	4103	4297	4589
<b>SETTEE</b> W: 47.5 SW: 44		<b>CMMARS-2</b>	Straight	5.5	3276	3480	3727	3953	4195	4431	4673	4910	5267
<b>SOFA</b> W: 69.5 SW: 66		<b>CMMARS-3</b>	Straight	8.25	4424	4729	5101	5439	5802	6157	6520	6874	7411

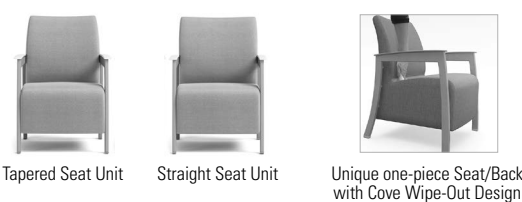

Tapered Seat Unit      Straight Seat Unit      Unique one-piece Seat/Back with Cove Wipe-Out Design

## MARINA METAL | SOLID SURFACE ARM CAPS

	MODEL	GRADE	A	B	C	D	
<b>SOLID SURFACE ARM CAPS</b>		<b>ACMMS</b>	Stocked Solid Surface	NC	NC	42 LIST/PR	76 LIST/PR
			Non-stocked (per color, per order)	ADD	410 NET	450 NET	490 NET

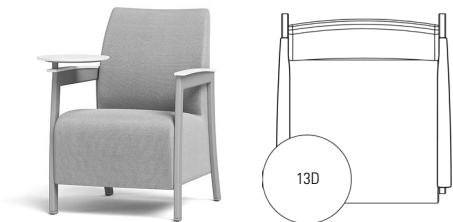

CHOOSE POSITION

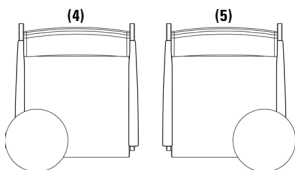

(4) - Tablet on right as seated

(5) - Tablet on left as seated

13" ROUND SOLID SURFACE TABLET OPTION

MODEL	GRADE	A	B	C	D
ST4-(4/5)	Stocked	670 LIST	695 LIST	730 LIST	789 LIST
	Non-stocked (per color, per order)	ADD 410 NET	450 NET	490 NET	520 NET

13" ROUND LAMINATE OVER PLYWOOD CORE/EDGE TABLET OPTION

MODEL	GRADE	PRICE
LT4-(4/5)	Stocked (Laminate tablets have a plywood edge. Specify finish.)	572 LIST
	Non-stocked (per color, per order)	ADD 50 NET

13" ROUND VENEER OVER PLYWOOD CORE/EDGE TABLET OPTION

MODEL	GRADE	PRICE
VT4-(4/5)	Standard Wood Finish	572 LIST
	Custom Finish (one time charge per color)	ADD 300 NET

MARINA METAL | OTHER OPTIONS

METAL STAND-OFFS

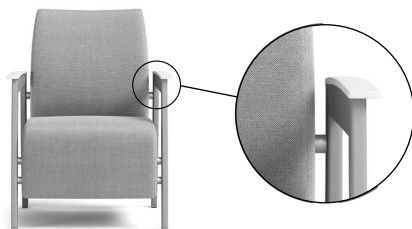

MODEL	DESCRIPTION	PRICE
SPANNERS	Adds 1.5" to seat width and overall width for cleanability	260 LIST/SET

SECURE BOTTOM COVERS



MODEL	SEAT WIDTH	PRICE
SBC	22"	182 LIST
	27"	193 LIST
	32"	193 LIST
	42"	219 LIST

NOTE: Secure Bottom Covers include tamper-resistant fasteners. Available on individual units only, not on Settee or Sofa.

PRODUCT OPTIONS

**MOISTURE BARRIER** \$48 List / Yard; Note: Moisture Barrier may telegraph through thinner textiles.  
**FIRE WALL / CA T.B. 133** \$82 List / Yard  
**WEIGHTED / THEFT DETERRENT** \$333 List / 25 lb Weight  
 \$666 List / 50 lb Weight





MARINA UPHOLSTERED ARM | TABLET OPTIONS

ALL INTEGRA TABLETS HAVE A 300LB CAPACITY



Tablets available in Upholstered Arms with and without Arm Caps.

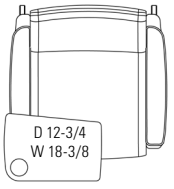

With Cup Holder Option

CHOOSE POSITION

(4)



(4) - Tablet on right as seated

(5)



(5) - Tablet on left as seated

SOLID SURFACE TABLET OPTION

MODEL	GRADE	A	B	C	D
ST-(4/5)	Stocked	790 LIST	828 LIST	886 LIST	976 LIST
	Non-stocked (per color, per order)	ADD 410 NET	450 NET	490 NET	520 NET

LAMINATE OVER PLYWOOD CORE/EDGE TABLET OPTION

MODEL	GRADE	PRICE
LT-(4/5)	Stocked (Laminate tablets have a plywood edge. Specify finish.)	598 LIST
	Non-stocked (per color, per order)	ADD 50 NET

VENEER OVER PLYWOOD CORE/EDGE TABLET OPTION

MODEL	GRADE	PRICE
VT-(4/5)	Standard Wood Finish	598 LIST
	Custom Finish (one time charge per color)	ADD 300 NET

CUP HOLDER

MODEL	FINISH	PRICE
CUPIN	Brushed Aluminum	236 LIST

MARINA UPHOLSTERED ARM | OTHER OPTIONS

METAL STAND-OFFS

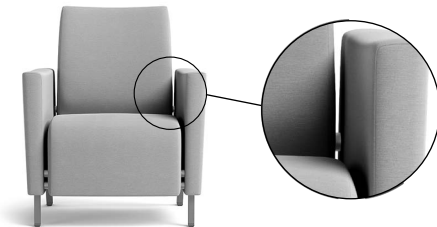

MODEL	DESCRIPTION	PRICE
SPANNERS	Adds 1.5" to seat width and overall width for cleanability	260 LIST/SET

SECURE BOTTOM COVERS

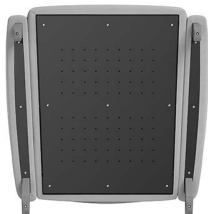

MODEL	SEAT WIDTH	PRICE
SBC	22"	182 LIST
	27"	193 LIST
	32"	193 LIST
	42"	219 LIST

**NOTE: Secure Bottom Covers include tamper-resistant fasteners. Available on individual units only, not on Settee or Sofa.**

PRODUCT OPTIONS

**MOISTURE BARRIER** \$48 List / Yard; Note: Moisture Barrier may telegraph through thinner textiles.  
**FIRE WALL / CA T.B. 133** \$82 List / Yard  
**WEIGHTED / THEFT DETERRENT** \$333 List / 25 lb Weight  
 \$666 List / 50 lb Weight



# COASTAL COLLECTION METAL | REEF METAL



## REEF UPHOLSTERED ARM WITH METAL LEGS

POWDER COATED STEEL

	MODEL	STYLE	YARDS	COM	M	COL			S	T	U	W/WL
<b>CHAIR - 24" SW</b> W: 34/34.5 D: 32.5 H: 37 SW: 24 SD: 21 SH: 17.5 BH: 23 AH: 24.5	<b>CRFMU-1-24</b>	Tapered	6	2790	3012	3282	3528	3792	4050	4314	4572	4962
	<b>CRFMUC-1-24</b>	Tapered	6	2790	3012	3282	3528	3792	4050	4314	4572	4962
	<b>CRFMUS-1-24</b>	Straight	6	2790	3012	3282	3528	3792	4050	4314	4572	4962
	<b>CRFMUCS-1-24</b>	Straight	6	2790	3012	3282	3528	3792	4050	4314	4572	4962



<b>CHAIR - 44" SW</b> W: 54/54.5 SW: 44	<b>CRFMU-1-44</b>	Tapered	7	3716	3975	4290	4577	4885	5186	5494	5795	6250
	<b>CRFMUC-1-44</b>	Tapered	7	3716	3975	4290	4577	4885	5186	5494	5795	6250
	<b>CRFMUS-1-44</b>	Straight	7	3716	3975	4290	4577	4885	5186	5494	5795	6250
	<b>CRFMUCS-1-44</b>	Straight	7	3716	3975	4290	4577	4885	5186	5494	5795	6250

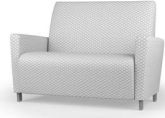

<b>SETTEE</b> W: 58 SW: 48	<b>CRFMUS-2</b>	Straight	9.5	4415	4767	5194	5584	6002	6410	6828	7237	7854
	<b>CRFMUCS-2</b>	Straight	9.5	4415	4767	5194	5584	6002	6410	6828	7237	7854



<b>SOFA</b> W: 82 SW: 72	<b>CRFMUS-3</b>	Straight	13	6040	6521	7106	7639	8211	8770	9342	9901	10746
	<b>CRFMUCS-3</b>	Straight	13	6040	6521	7106	7639	8211	8770	9342	9901	10746



Standard  
(CRFMU or CRFMUS)



Clean Out  
(CRFMUC or CRFMUCS)

## REEF UPHOLSTERED ARM | ARM CAP OPTIONS

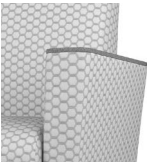
	MODEL	GRADE	A	B	C	D
<b>SOLID SURFACE ARM CAPS</b> 	<b>ACRFUS</b>	Stocked Solid Surface	500 LIST/PR	500 LIST/PR	632 LIST/PR	764 LIST/PR
		Non-stocked (per color, per order)	ADD	410 NET	450 NET	490 NET

	MODEL	DESCRIPTION	PRICE
<b>WOOD ARM CAPS</b> 	<b>ACRFM</b>	Solid Wood. Specify finish.	378 LIST/PR





## REEF UPHOLSTERED ARM | TABLET OPTIONS



Tablets available in Upholstered Arms with and without Arm Caps.



With Cup Holder Option

### CHOOSE POSITION

(4)

(5)

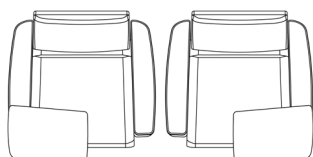

(4) - Tablet on right as seated

(5) - Tablet on left as seated

### SOLID SURFACE TABLET OPTION

MODEL	GRADE	A	B	C	D
ST-(4/5)	Stocked	790 LIST	828 LIST	886 LIST	976 LIST
	Non-stocked (per color, per order)	ADD 410 NET	450 NET	490 NET	520 NET

### LAMINATE OVER PLYWOOD CORE/EDGE TABLET OPTION

MODEL	GRADE	PRICE
LT-(4/5)	Stocked (Laminate tablets have a plywood edge. Specify finish.)	598 LIST
	Non-stocked (per color, per order)	ADD 50 NET

### VENEER OVER PLYWOOD CORE/EDGE TABLET OPTION

MODEL	GRADE	PRICE
VT-(4/5)	Standard Wood Finish	598 LIST
	Custom Finish (one time charge per color)	ADD 300 NET

### CUP HOLDER

MODEL	FINISH	PRICE
CUPIN	Brushed Aluminum	236 LIST

### PRODUCT OPTIONS







**MOISTURE BARRIER** \$48 List / Yard; Note: Moisture Barrier may telegraph through thinner textiles.

**FIRE WALL / CA T.B. 133** \$82 List / Yard

**WEIGHTED / THEFT DETERRENT** \$333 List / 25 lb Weight

\$666 List / 50 lb Weight



	MODEL	YARDS	COM	M	COL O	P	R	S	T	U	W/WL	
<b>BAR LEGS</b> W: 23.5 D: 28 H: 31 SW: 23.5 SD: 18.5 SH: 18.5 BH: 12.5		<b>SEA1-BL</b>	3	1096	1207	1342	1465	1597	1726	1858	1987	2182
<b>360° SWIVEL WITH SELF-RETURN BASE</b>		<b>SEA1-SW</b>	3	1565	1676	1811	1934	2066	2195	2327	2456	2651
<b>STATIC BASE</b>		<b>SEA1-ST</b>	3	1519	1630	1765	1888	2020	2149	2281	2410	2605
<b>SLED BASE</b>		<b>SEA1-SB</b>	3	1226	1337	1472	1595	1727	1856	1988	2117	2312
<b>CASTERS</b>		<b>SEA1-C4</b>	3	1136	1247	1382	1505	1637	1766	1898	2027	2222
<b>PLINTH BASE</b>		<b>SEA1-PB</b>	3	1536	1647	1782	1905	2037	2166	2298	2427	2622

**NOTE: Plinth Base includes black Secure Bottom Cover and tamper-resistant fasteners.**

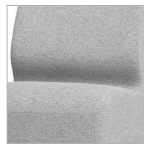

Unique one-piece Seat/Back with Cove Wipe-Out Design



SEASIDE LOUNGE | TABLET OPTIONS

ALL INTEGRA TABLETS HAVE A 300LB CAPACITY

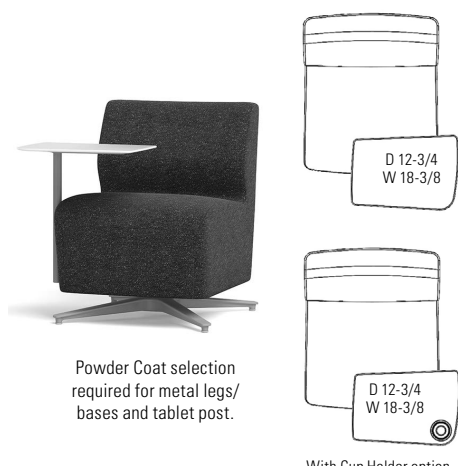

Powder Coat selection required for metal legs/bases and tablet post.

CHOOSE POSITION

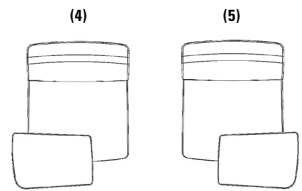

- (4) - Tablet on right as seated
- (5) - Tablet on left as seated

SOLID SURFACE TABLET OPTION

MODEL	GRADE		A	B	C	D
ST-(4/5)	Stocked		1115 LIST	1153 LIST	1211 LIST	1301 LIST
	Non-stocked (per color, per order)	ADD	410 NET	450 NET	490 NET	520 NET

LAMINATE OVER PLYWOOD CORE/EDGE TABLET OPTION

MODEL	GRADE	PRICE
LT-(4/5)	Stocked (Laminate tablets have a plywood edge. Specify finish.)	923 LIST
	Non-stocked (per color, per order)	ADD 50 NET

VENEER OVER PLYWOOD CORE/EDGE TABLET OPTION

MODEL	GRADE	PRICE
VT-(4/5)	Standard Wood Finish	923 LIST
	Custom Finish (one time charge per color)	ADD 300 NET

CUP HOLDER

MODEL	FINISH	PRICE
CUPIN	Brushed Aluminum	236 LIST

NOTE: Tablets are available on armless units only.

External Tablets on Seaside Chairs require 20 lb of counterweight for stability, which is included in the above pricing.

SEASIDE LOUNGE | ARM OPTIONS

METAL ARMS WITH SOLID SURFACE ARM CAPS

D: 24  
H: 25



MODEL	W	GRADE		A	B	C	D
SEAM AL/AR PAIR OF ARMS	6	Stocked Solid Surface		676 LIST/PR	706 LIST/PR	748 LIST/PR	806 LIST/PR
		Non-stocked (per color, per order)	ADD	410 NET	450 NET	490 NET	520 NET

UPHOLSTERED ARMS

D: 23  
H: 25



MODEL	W	YARDS	COM	M	COL									
					O	P	R	S	T	U	W/WL			
SEAU AL/AR PAIR OF ARMS	8	2	794	868	958	1040	1128	1214	1302	1388	1518			

SEASIDE LOUNGE | ARM CAP OPTIONS

SOLID SURFACE ARM CAPS FOR UPHOLSTERED ARMS

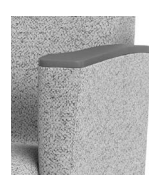

MODEL	GRADE		A	B	C	D
ACSEAU	Stocked Solid Surface		322 LIST/PR	352 LIST/PR	392 LIST/PR	448 LIST/PR
	Non-stocked (per color, per order)	ADD	410 NET	450 NET	490 NET	520 NET



SEASIDE LOUNGE | OTHER OPTIONS

	MODEL	DESCRIPTION	PRICE
<b>RECESSED PULL HANDLE</b>	<b>RPH(B/G)</b>	For use with mobile options. Specify Black (B) or Gray (G).	94 LIST



	MODEL	PRICE
<b>SECURE BOTTOM COVERS (NON-PLINTH)</b>	<b>SBC</b>	163 LIST



**NOTE: Secure Bottom Covers include tamper-resistant fasteners.**

**PRODUCT OPTIONS**

- MOISTURE BARRIER** \$48 List / Yard; Note: Moisture Barrier may telegraph through thinner textiles.
- FIRE WALL / CA T.B. 133** \$82 List / Yard
- WEIGHTED / THEFT DETERRENT** \$333 List / 25 lb Weight (MAXIMUM OF 2)





# COASTAL COLLECTION METAL | TIDE METAL



## LOW TIDE METAL WITH SOLID SURFACE ARM CAPS - WALL SAVER DESIGN

POWDER COATED STEEL

		MODEL	W	SW	YARDS	COM	M	COL					U	W/WL
								O	P	R	S	T		
<b>CHAIR</b>		<b>CTMLO-1-22</b>	25.75	22	2	1812	1886	1976	2058	2146	2232	2320	2406	2536
		<b>CTMLO-1-27</b>	30.75	27	2.5	1967	2060	2172	2275	2385	2492	2602	2710	2872
		<b>CTMLO-1-32</b>	35.75	32	2.75	2235	2337	2461	2573	2694	2813	2934	3052	3231
		<b>CTMLO-1-42</b>	45.75	42	3	2521	2632	2767	2890	3022	3151	3283	3412	3607
<b>SETTEE</b>		<b>CTMLO-2</b>	47.75	44	4	2524	2672	2852	3016	3192	3364	3540	3712	3972
<b>ORTHO HEIGHT SEATING</b>		<b>CTMLOOR-1-22</b>	25.75	22	2	2216	2290	2380	2462	2550	2636	2724	2810	2940
		<b>CTMLOOR-1-27</b>	30.75	27	2.5	2437	2530	2642	2745	2855	2962	3072	3180	3342
		<b>CTMLOOR-1-32</b>	35.75	32	2.75	2758	2860	2984	3096	3217	3336	3457	3575	3754

H: 34 D: 27.5  
 SH: 18.5 SD: 19  
 BH: 16.5 AH: 26



### SETTEE

### ORTHO HEIGHT SEATING

H: 39.75 D: 27.5  
 SH: 24.5 AH: 31.5

Step adds to overall depth

## HIGH TIDE METAL WITH SOLID SURFACE ARM CAPS

		MODEL	W	SW	YARDS	COM	M	COL					U	W/WL
								O	P	R	S	T		
<b>CHAIR</b>		<b>CTMHI-1-22</b>	25.75	22	2.25	1851	1934	2036	2128	2227	2324	2423	2519	2666
		<b>CTMHI-1-27</b>	30.75	27	2.75	1982	2084	2208	2320	2441	2560	2681	2799	2978
		<b>CTMHI-1-32</b>	35.75	32	3	2275	2386	2521	2644	2776	2905	3037	3166	3361
		<b>CTMHI-1-42</b>	45.75	42	3.5	2555	2685	2842	2986	3140	3290	3444	3595	3822
<b>SETTEE</b>		<b>CTMHI-2</b>	47.75	44	4.5	2602	2769	2971	3156	3354	3547	3745	3939	4231
<b>ORTHO HEIGHT SEATING</b>		<b>CTMHIOR-1-22</b>	25.75	22	2.25	2255	2338	2440	2532	2631	2728	2827	2923	3070
		<b>CTMHIOR-1-27</b>	30.75	27	2.75	2452	2554	2678	2790	2911	3030	3151	3269	3448
		<b>CTMHIOR-1-32</b>	35.75	32	3	2798	2909	3044	3167	3299	3428	3560	3689	3884

H: 36.75 D: 27.5  
 SH: 18.5 SD: 19  
 BH: 20 AH: 26



### SETTEE

### ORTHO HEIGHT SEATING

H: 42.75 D: 27.5  
 SH: 24.5 AH: 31.5

Step adds to overall depth

## PATIENT BACK TIDE METAL WITH SOLID SURFACE ARM CAPS

		MODEL	W	SW	YARDS	COM	M	COL					U	W/WL
								O	P	R	S	T		
<b>CHAIR</b>		<b>CTMPT-1-22</b>	25.75	22	3	2076	2187	2322	2445	2577	2706	2838	2967	3162
		<b>CTMPT-1-27</b>	30.75	27	3.25	2250	2370	2517	2650	2793	2933	3076	3215	3427
<b>ORTHO HEIGHT SEATING</b>		<b>CTMPTOR-1-22</b>	25.75	22	3	2480	2591	2726	2849	2981	3110	3242	3371	3566
		<b>CTMPTOR-1-27</b>	30.75	27	3.25	2720	2840	2987	3120	3263	3403	3546	3685	3897

H: 47.75 D: 29  
 SH: 18.5 SD: 20  
 BH: 30 AH: 26



### ORTHO HEIGHT SEATING

H: 53.5 D: 29  
 SH: 24.5 AH: 31.5



Step adds to overall depth



## LOW TIDE METAL ARMLESS

	MODEL	W	SW	YARDS	COM	M	COL						W/WL	
							O	P	R	S	T	U		
<b>CHAIR</b> H: 34 D: 27.5 SH: 18.5 SD: 19 BH: 16.5		<b>CTMALO-1-22</b>	24	22	2	1588	1662	1752	1834	1922	2008	2096	2182	2312
	<b>CTMALO-1-27</b>	29	27	2.5	1743	1836	1948	2051	2161	2268	2378	2486	2648	
	<b>CTMALO-1-32</b>	34	32	2.75	2011	2113	2237	2349	2470	2589	2710	2828	3007	
	<b>CTMALO-1-42</b>	44	42	3	2297	2408	2543	2666	2798	2927	3059	3188	3383	
<b>SETTEE</b> 	<b>CTMALO-2</b>	46	44	4	2300	2448	2628	2792	2968	3140	3316	3488	3748	

## HIGH TIDE METAL ARMLESS

	MODEL	W	SW	YARDS	COM	M	COL						W/WL	
							O	P	R	S	T	U		
<b>CHAIR</b> H: 36.75 D: 27.5 SH: 18.5 SD: 19 BH: 20		<b>CTMAHI-1-22</b>	24	22	2.25	1627	1710	1812	1904	2003	2100	2199	2295	2442
	<b>CTMAHI-1-27</b>	29	27	2.75	1758	1860	1984	2096	2217	2336	2457	2575	2754	
	<b>CTMAHI-1-32</b>	34	32	3	2051	2162	2297	2420	2552	2681	2813	2942	3137	
	<b>CTMAHI-1-42</b>	44	42	3.5	2331	2461	2618	2762	2916	3066	3220	3371	3598	
<b>SETTEE</b> 	<b>CTMAHI-2</b>	46	44	4.5	2378	2545	2747	2932	3130	3323	3521	3715	4007	

## PATIENT BACK TIDE METAL ARMLESS

	MODEL	W	SW	YARDS	COM	M	COL						W/WL	
							O	P	R	S	T	U		
<b>CHAIR</b> H: 47.75 D: 29 SH: 18.5 SD: 20 BH: 30		<b>CTMAPT-1-22</b>	24	22	3	1852	1963	2098	2221	2353	2482	2614	2743	2938
	<b>CTMAPT-1-27</b>	29	27	3.25	2026	2146	2293	2426	2569	2709	2852	2991	3203	

## TIDE METAL | SEAT OPTIONS

	DESCRIPTION	PRICE
<b>CLEAN-OUT SEAT</b> 	Standard on Tide seating. Allows for easier cleaning and has Wear Point Seat Rotation.	No Upcharge

	MODEL	DESCRIPTION	PRICE
<b>ISLAND SEAT / ALL-SIDE CLEAN-OUT</b> 	<b>CI</b>	All sides clean out. Includes Metal Sleeves.	100 LIST/SEAT

**NOTE: Also available on System Seating shown on next page. Allows for easiest cleaning and has Wear Point Seat Rotation.**



## TIDE METAL | SOLID SURFACE ARM CAPS

### SOLID SURFACE ARM CAPS



MODEL	GRADE		A	B	C	D
<b>ACTMS</b>	Stocked Solid Surface		NC	NC	40 LIST/PR	76 LIST/PR
	Non-stocked (per color, per order)	ADD	410 NET	450 NET	490 NET	520 NET

## TIDE METAL | TABLET OPTIONS

ALL INTEGRA TABLETS HAVE A 300LB CAPACITY

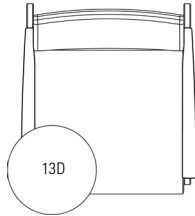

### CHOOSE POSITION

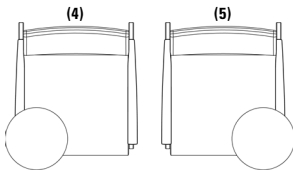

- (4) - Tablet on right as seated
- (5) - Tablet on left as seated

### 13" ROUND SOLID SURFACE TABLET OPTION

MODEL	GRADE		A	B	C	D
<b>ST4-(4/5)</b>	Stocked		670 LIST	695 LIST	730 LIST	789 LIST
	Non-stocked (per color, per order)	ADD	410 NET	450 NET	490 NET	520 NET

### 13" ROUND LAMINATE OVER PLYWOOD CORE/EDGE TABLET OPTION

MODEL	GRADE		PRICE
<b>LT4-(4/5)</b>	Stocked (Laminate tablets have a plywood edge. Specify finish.)		572 LIST
	Non-stocked (per color, per order)	ADD	50 NET

### 13" ROUND VENEER OVER PLYWOOD CORE/EDGE TABLET OPTION

MODEL	GRADE		PRICE
<b>VT4-(4/5)</b>	Standard Wood Finish		572 LIST
	Custom Finish (one time charge per color)	ADD	300 NET

## TIDE METAL | OTHER OPTIONS

### CONNECTING BRACKET



MODEL	DESCRIPTION	PRICE
<b>CTMGB</b>	Powder coat color must be specified	257 LIST

### PRODUCT OPTIONS

**MOISTURE BARRIER** \$48 List / Yard; Note: Moisture Barrier may telegraph through thinner textiles.  
**FIRE WALL / CA T.B. 133** \$82 List / Yard  
**TAMPER-RESISTANT FASTENERS** \$56 List / Chair



TIDE METAL SYSTEM ARMS



POWDER COATED STEEL

	MODEL	GRADE	A	B	C	D	
<b>TIDE METAL ARM</b> W: 2 D: 26.5 H: 26		<b>CTM( )</b>					
		<b>AL/TS or AR/ST</b>	Stocked Solid Surface	545 LIST	545 LIST	565 LIST	583 LIST
		<b>SS</b>	Stocked Solid Surface	577 LIST	577 LIST	597 LIST	615 LIST
		Non-Stocked (per color, per order)	ADD	410 NET	450 NET	490 NET	520 NET



	MODEL	PRICE	
<b>TIDE METAL ARMLESS</b> W: 1 D: 26.5 H: 24.75		<b>CTAM( )</b>	
		<b>AL/TS or AR/ST</b>	433 LIST
		<b>SS</b>	465 LIST

AL/TS: Arm Left/Table-to-Seat Connection, AR/ST: Arm Right/Seat-to-Table Connection, SS: Seat-to-Seat Connection

LOW TIDE SYSTEM SEATS

	MODEL	SW	YARDS	COM	M	COL								W/WL
						O	P	R	S	T	U			
<b>SINGLE SEAT</b> SD: 19 BH: 16.5		<b>CLT1</b>	22	2	722	796	886	968	1056	1142	1230	1316	1446	
		<b>CLT2</b>	27	2.5	877	970	1082	1185	1295	1402	1512	1620	1782	
		<b>CLT3</b>	32	2.75	1145	1247	1371	1483	1604	1723	1844	1962	2141	
		<b>CLT4</b>	42	3	1431	1542	1677	1800	1932	2061	2193	2322	2517	
<b>DOUBLE SEAT</b>		<b>CLT12</b>	44	4	1434	1582	1762	1926	2102	2274	2450	2622	2882	

HIGH TIDE SYSTEM SEATS

	MODEL	SW	YARDS	COM	M	COL								W/WL
						O	P	R	S	T	U			
<b>SINGLE SEATS</b> SD: 19 BH: 20		<b>CHT1</b>	22	2.25	761	844	946	1038	1137	1234	1333	1429	1576	
		<b>CHT2</b>	27	2.75	892	994	1118	1230	1351	1470	1591	1709	1888	
		<b>CHT3</b>	32	3	1185	1296	1431	1554	1686	1815	1947	2076	2271	
		<b>CHT4</b>	42	3.5	1465	1595	1752	1896	2050	2200	2354	2505	2732	
<b>DOUBLE SEAT</b>		<b>CHT12</b>	44	4.5	1511	1678	1880	2065	2263	2456	2654	2848	3140	

TIDE PATIENT SYSTEM SEATS

	MODEL	SW	YARDS	COM	M	COL								W/WL
						O	P	R	S	T	U			
<b>SINGLE SEATS</b> SD: 20 BH: 30		<b>CPT1</b>	22	3	986	1097	1232	1355	1487	1616	1748	1877	2072	
		<b>CPT2</b>	27	3.25	1160	1280	1427	1560	1703	1843	1986	2125	2337	

PRODUCT OPTIONS

- MOISTURE BARRIER** \$48 List / Yard; Note: Moisture Barrier may telegraph through thinner textiles.
- FIRE WALL / CA T.B. 133** \$82 List / Yard
- TAMPER-RESISTANT FASTENERS** \$56 List / Chair
- ARM CAPS, TABLETS, AND ISLAND SEAT OPTIONS** See pages CCM-14 and CCM-15.

NOTE: Tide System Seating typically ships in 3 seat units (maximum).







# TIDE METAL SOLID SURFACE SYSTEM TABLES

	MODEL	GRADE	A	B	C	D	
<b>END TABLE</b> W: 21 D: 21 H: 15		<b>CTM80-S</b>	Stocked Solid Surface	1111 LIST	1204 LIST	1337 LIST	1549 LIST
			Non-stocked (per color, per order)	ADD 410 NET	450 NET	490 NET	520 NET

**NOTE: 1.25" Metal Cylinder Leg**

	MODEL	GRADE	A	B	C	D	
<b>IN-LINE TABLE</b> W: 21 D: 21 H: 15		<b>CTM81-S</b>	Stocked Solid Surface	1154 LIST	1247 LIST	1380 LIST	1592 LIST
			Non-stocked (per color, per order)	ADD 410 NET	450 NET	490 NET	520 NET

	MODEL	GRADE	A	B	C	D	
<b>90° TWO-WAY TABLE</b> W: 27 D: 27 H: 15		<b>CTM82-S</b>	Stocked Solid Surface	1346 LIST	1448 LIST	1600 LIST	1839 LIST
			Non-stocked (per color, per order)	ADD 410 NET	450 NET	490 NET	520 NET

**NOTE: 1.25" Metal Cylinder Leg**

Allow 30" for 90° corner



TIDE METAL SEAT-TO-TABLE  
CONNECTING BRACKETS ARE  
INCLUDED IN TABLE PRICING ABOVE.



## TIDE METAL SYSTEM SPECIFICATION

Integra systems are listed separately from the freestanding product of each series throughout this price list. The components are specific to the model and are all shown within the systems sections. Each system arm, system seat, and system table has a specific item number. System arms must have placement specified as shown below, and system tables must specify choice of edge and leg details.

WHEN SPECIFYING SYSTEMS, ALWAYS ITEMIZE COMPONENTS AS YOU STAND FACING THE CONFIGURATION. BEGIN YOUR LAYOUT AT THE LEFT AND END AT THE RIGHT.

The seat unit and table components are shown in each system area of this price list.

All System orders require a layout at the time of order. This is to ensure you are ordering all components necessary for that layout.

System arms use an alpha designation which describes their placement:

**SS** is for Seat-to-Seat Connection

**ST** is for Seat-to-Table Connection

**TS** is for Table-to-Seat Connection

**AR** is for Arm Right

**AL** is for Arm Left

EXAMPLES (in Tide series):

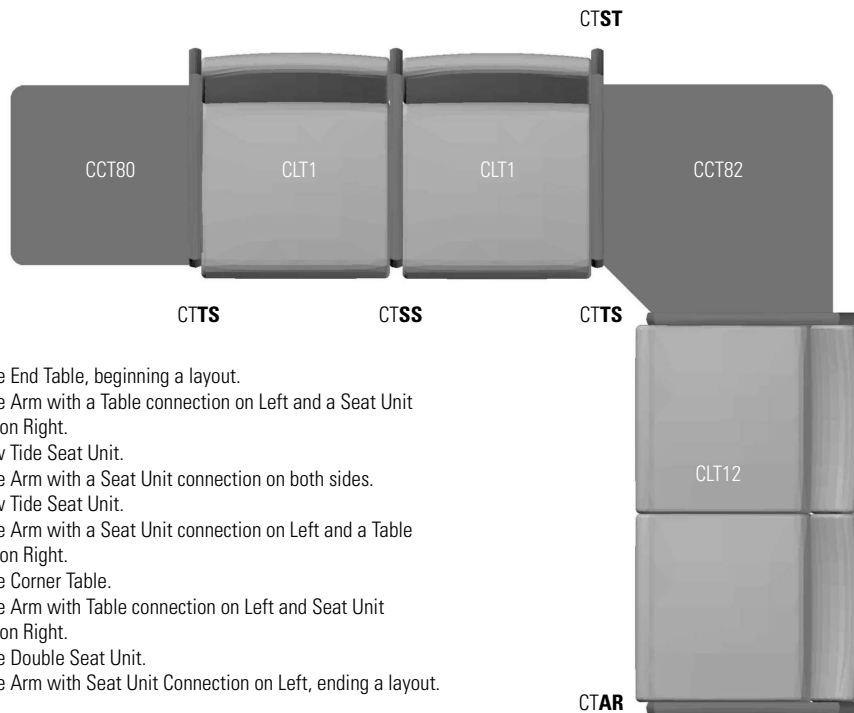

- CCT80 Coastal Tide End Table, beginning a layout.
- CTTS Coastal Tide Arm with a Table connection on Left and a Seat Unit connection on Right.
- CLT1 Coastal Low Tide Seat Unit.
- CTSS Coastal Tide Arm with a Seat Unit connection on both sides.
- CLT1 Coastal Low Tide Seat Unit.
- CTST Coastal Tide Arm with a Seat Unit connection on Left and a Table connection on Right.
- CCT82 Coastal Tide Corner Table.
- CTTS Coastal Tide Arm with Table connection on Left and Seat Unit connection on Right.
- CLT12 Coastal Tide Double Seat Unit.
- CTAR Coastal Tide Arm with Seat Unit Connection on Left, ending a layout.

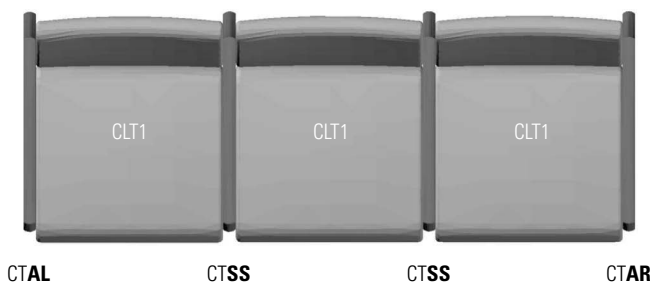

- CTAL Coastal Tide Arm, beginning a layout, connecting to a Seat Unit on right.
- CLT1 Coastal Low Tide Seat Unit.
- CTSS Coastal Tide Arm with a Seat Unit connection on both sides.
- CLT1 Coastal Low Tide Seat Unit.
- CTSS Coastal Tide Arm with a Seat Unit connection on both sides.
- CLT1 Coastal Low Tide Seat Unit.
- CTAR Coastal Tide Arm with Seat Unit Connection on Left, ending a layout.

**NOTE: Tide System Seating typically ships in 3 seat units (maximum).**



## TIDE FOOTSTOOL

### FOOTSTOOL

W: 19.25

D: 19.5



MODEL	H	YARDS	COM	M	COL							
					O	P	R	S	T	U	W/WL	
CTFS1	13.25	1.5	514	570	637	699	765	829	895	960	1057	
CTFS2	18	1.5	563	619	686	748	814	878	944	1009	1106	

### RECESSED PULL HANDLE



MODEL	DESCRIPTION	PRICE
RPH(B/G)	Specify Black (B) or Gray (G)	94 LIST

### PRODUCT OPTIONS

**MOISTURE BARRIER** \$48 List / Yard; Note: Moisture Barrier may telegraph through thinner textiles.  
**FIRE WALL / CA T.B. 133** \$82 List / Yard  
**WEIGHTED / THEFT DETERRENT** \$333 List / 25 lb Weight

## LOW TIDE REPLACEMENT BACK ONLY

### LOW TIDE SINGLE BACK



MODEL	SW	YARDS	COM	M	COL							
					O	P	R	S	T	U	W/WL	
CLB1	22	1	319	356	401	442	486	529	573	616	681	
Cover Only	22	1	93	130	175	216	260	303	347	390	455	
CLB2	27	1.5	418	474	541	603	669	733	799	864	961	
Cover Only	27	1.5	140	196	263	325	391	455	521	586	683	
CLB3	32	1.5	504	560	627	689	755	819	885	950	1047	
Cover Only	32	1.5	140	196	263	325	391	455	521	586	683	
CLB4	42	1.5	621	677	744	806	872	936	1002	1067	1164	
Cover Only	42	1.5	140	196	263	325	391	455	521	586	683	

## HIGH TIDE REPLACEMENT BACK ONLY

### HIGH TIDE SINGLE BACK



MODEL	SW	YARDS	COM	M	COL							
					O	P	R	S	T	U	W/WL	
CHB1	22	1.25	358	404	461	512	567	621	676	729	811	
Cover Only	22	1.25	116	162	219	270	325	379	434	487	569	
CHB2	27	1.75	433	498	577	648	725	801	878	953	1067	
Cover Only	27	1.75	163	228	307	378	455	531	608	683	797	
CHB3	32	1.75	544	609	688	759	836	912	989	1064	1178	
Cover Only	32	1.75	163	228	307	378	455	531	608	683	797	
CHB4	42	2	655	729	819	901	989	1075	1163	1249	1379	
Cover Only	42	2	186	260	350	432	520	606	694	780	910	

## PATIENT TIDE REPLACEMENT BACK ONLY

### PATIENT TIDE SINGLE BACK



MODEL	SW	YARDS	COM	M	COL							
					O	P	R	S	T	U	W/WL	
CPB1	22	2	583	657	747	829	917	1003	1091	1177	1307	
Cover Only	22	2	186	260	350	432	520	606	694	780	910	
CPB2	27	2.25	701	784	886	978	1077	1174	1273	1369	1516	
Cover Only	27	2.25	209	292	394	486	585	682	781	877	1024	



## TIDE REPLACEMENT SEAT ONLY

	MODEL	SW	YARDS	COM	M	COL						W/WL
						O	P	R	S	T	U	
<b>TIDE STANDARD SEAT</b> 	<b>CTS1</b>	22	1	314	351	396	437	481	524	568	611	676
	<b>Cover Only</b>	22	1	93	130	175	216	260	303	347	390	455
	<b>CTS2</b>	27	1	358	395	440	481	525	568	612	655	720
	<b>Cover Only</b>	27	1	93	130	175	216	260	303	347	390	455
	<b>CTS3</b>	32	1.25	514	560	617	668	723	777	832	885	967
	<b>Cover Only</b>	32	1.25	116	162	219	270	325	379	434	487	569
	<b>CTS4</b>	42	1.5	650	706	773	835	901	965	1031	1096	1193
	<b>Cover Only</b>	42	1.5	140	196	263	325	391	455	521	586	683

	MODEL	SW	YARDS	COM	M	COL						W/WL
						O	P	R	S	T	U	
<b>TIDE ISLAND SEAT</b> 	<b>CIS1</b>	22	1	314	351	396	437	481	524	568	611	676
	<b>Cover Only</b>	22	1	93	130	175	216	260	303	347	390	455
	<b>CIS2</b>	27	1	358	395	440	481	525	568	612	655	720
	<b>Cover Only</b>	27	1	93	130	175	216	260	303	347	390	455
	<b>CIS3</b>	32	1.25	514	560	617	668	723	777	832	885	967
	<b>Cover Only</b>	32	1.25	116	162	219	270	325	379	434	487	569
	<b>CIS4</b>	42	1.5	650	706	773	835	901	965	1031	1096	1193
	<b>Cover Only</b>	42	1.5	140	196	263	325	391	455	521	586	683

MODEL	PRICE
<b>ISLAND SEAT METAL SLEEVES - REPLACEMENT SLEEVES ONLY</b> <b>CTSLEEVES4</b>	100 LIST/CHAIR

## TIDE METAL | ARM CAP REPLACEMENTS

MODEL	GRADE	A	B	C	D
<b>SOLID SURFACE ARM CAPS</b> 	<b>ACTMS</b> Stocked Solid Surface	224 LIST/PR	224 LIST/PR	264 LIST/PR	300 LIST/PR
	Non-stocked (per color, per order) ADD	410 NET	450 NET	490 NET	520 NET



# COASTAL COLLECTION METAL | BENCHES



CERTIFIED  
CLEAN AIR GOLD



COMPONENT-BASED  
CONSTRUCTION





2K STATIC  
CAPACITY



1K DROP  
CAPACITY

## COASTAL METAL BENCHES WITH SOLID SURFACE ARM CAPS

POWDER COATED STEEL

	MODEL	YARDS	COM	M	COL			S	T	U	W/WL
<b>44.25 BENCH</b> W: 44.25 D: 21.25 H: 20.75 SW: 42 SD: 21 SH: 18.5	 <b>CBNM-7-42</b>	2	1607	1681	1771	1853	1941	2027	2115	2201	2331
<b>62.25 BENCH</b> W: 62.25 SW: 60	 <b>CBNM-7-60</b>	3	1954	2065	2200	2323	2455	2584	2716	2845	3040
<b>74.25 BENCH</b> W: 74.25 SW: 72	 <b>CBNM-7-72</b>	3.5	2172	2302	2459	2603	2757	2907	3061	3212	3439

## COASTAL METAL BENCHES | ARM CAPS

### SOLID SURFACE ARM CAPS

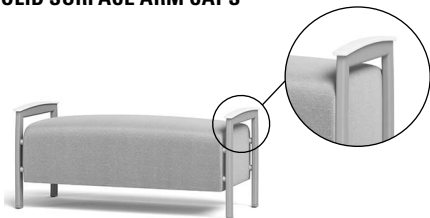

MODEL	GRADE	A	B	C	D
<b>ACBMS</b>	Stocked Solid Surface	NC	NC	42 LIST/PR	76 LIST/PR
	Non-stocked (per color, per order)	ADD	410 NET	450 NET	490 NET

## COASTAL METAL BENCHES | OTHER OPTIONS

### METAL STAND-OFFS

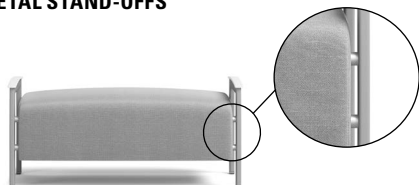

MODEL	DESCRIPTION	PRICE
<b>SPANNERS</b>	Adds 1.5" to seat width and overall width for cleanability	208 LIST/SET

### SECURE BOTTOM COVERS



MODEL	SEAT WIDTH	PRICE
<b>SBCCB42</b>	42"	190 LIST
<b>SBCCB60</b>	60"	268 LIST
<b>SBCCB72</b>	72"	268 LIST

**NOTE: Secure Bottom Covers include tamper-resistant fasteners.**

### PRODUCT OPTIONS

**MOISTURE BARRIER** \$48 List / Yard; Note: Moisture Barrier may telegraph through thinner textiles.  
**FIRE WALL / CA T.B. 133** \$82 List / Yard  
**WEIGHTED / THEFT DETERRENT** \$333 List / 25 lb Weight  
 \$666 List / 50 lb Weight



# COASTAL COLLECTION METAL | TABLES













CERTIFIED  
CLEAN AIR GOLD



COMPONENT-BASED  
CONSTRUCTION











## METAL PEDESTAL BASE WITH SOLID SURFACE TOPS

POWDER COATED STEEL

		MODEL	GRADE	A	B	C	D
<b>22 SQUARE x 17.5H</b> W: 22 D: 22 H: 17.5		<b>CMTPS-222217</b>	Stocked .5"-thick Solid Surface	1120	1212	1344	1511
			Non-stocked (per color, per order)	ADD	410 NET	450 NET	490 NET
<b>22 SQUARE x 20.5H</b> W: 22 D: 22 H: 20.5		<b>CMTPS-222220</b>	Stocked .5"-thick Solid Surface	1120	1212	1344	1511
			Non-stocked (per color, per order)	ADD	410 NET	450 NET	490 NET
<b>28 SQUARE x 17.5H</b> W: 28 D: 28 H: 17.5		<b>CMTPS-282817</b>	Stocked .5"-thick Solid Surface	1514	1634	1810	2048
			Non-stocked (per color, per order)	ADD	410 NET	450 NET	490 NET
<b>28 SQUARE x 20.5H</b> W: 28 D: 28 H: 20.5		<b>CMTPS-282820</b>	Stocked .5"-thick Solid Surface	1514	1634	1810	2048
			Non-stocked (per color, per order)	ADD	410 NET	450 NET	490 NET
<b>18 ROUND x 17.5H</b> DIA: 18 H: 17.5		<b>CMTPR-1817</b>	Stocked .5"-thick Solid Surface	1040	1123	1244	1433
			Non-stocked (per color, per order)	ADD	410 NET	450 NET	490 NET
<b>18 ROUND x 20.5H</b> DIA: 18 H: 20.5		<b>CMTPR-1820</b>	Stocked .5"-thick Solid Surface	1040	1123	1244	1433
			Non-stocked (per color, per order)	ADD	410 NET	450 NET	490 NET
<b>22 ROUND x 17.5H</b> DIA: 22 H: 17.5		<b>CMTPR-2217</b>	Stocked .5"-thick Solid Surface	1120	1212	1344	1511
			Non-stocked (per color, per order)	ADD	410 NET	450 NET	490 NET
<b>22 ROUND x 20.5H</b> DIA: 22 H: 20.5		<b>CMTPR-2220</b>	Stocked .5"-thick Solid Surface	1120	1212	1344	1511
			Non-stocked (per color, per order)	ADD	410 NET	450 NET	490 NET
<b>28 ROUND x 17.5H</b> DIA: 28 H: 17.5		<b>CMTPR-2817</b>	Stocked .5"-thick Solid Surface	1514	1634	1810	2048
			Non-stocked (per color, per order)	ADD	410 NET	450 NET	490 NET
<b>28 ROUND x 20.5H</b> DIA: 28 H: 20.5		<b>CMTPR-2820</b>	Stocked .5"-thick Solid Surface	1514	1634	1810	2048
			Non-stocked (per color, per order)	ADD	410 NET	450 NET	490 NET



## METAL CYLINDER LEGS WITH SOLID SURFACE TOPS

		MODEL	GRADE		A	B	C	D
<b>22 SQUARE x 17.5H</b> W: 22 D: 22 H: 17.5		<b>CMTLS-222217</b>	Stocked .5"-thick Solid Surface		1163	1255	1387	1554
			Non-stocked (per color, per order)	ADD	410 NET	450 NET	490 NET	520 NET
<b>22 SQUARE x 20.5H</b> W: 22 D: 22 H: 20.5		<b>CMTLS-222220</b>	Stocked .5"-thick Solid Surface		1163	1255	1387	1554
			Non-stocked (per color, per order)	ADD	410 NET	450 NET	490 NET	520 NET
<b>28 SQUARE x 17.5H</b> W: 28 D: 28 H: 17.5		<b>CMTLS-222217</b>	Stocked .5"-thick Solid Surface		1427	1547	1723	1961
			Non-stocked (per color, per order)	ADD	410 NET	450 NET	490 NET	520 NET
<b>28 SQUARE x 20.5H</b> W: 28 D: 28 H: 20.5		<b>CMTLS-222220</b>	Stocked .5"-thick Solid Surface		1427	1547	1723	1961
			Non-stocked (per color, per order)	ADD	410 NET	450 NET	490 NET	520 NET
<b>18 ROUND x 17.5H</b> DIA: 18 H: 17.5		<b>CMTLR-1817</b>	Stocked .5"-thick Solid Surface		1083	1166	1287	1476
			Non-stocked (per color, per order)	ADD	410 NET	450 NET	490 NET	520 NET
<b>18 ROUND x 20.5H</b> DIA: 18 H: 20.5		<b>CMTLR-1820</b>	Stocked .5"-thick Solid Surface		1083	1166	1287	1476
			Non-stocked (per color, per order)	ADD	410 NET	450 NET	490 NET	520 NET
<b>22 ROUND x 17.5H</b> DIA: 22 H: 17.5		<b>CMTLR-2217</b>	Stocked .5"-thick Solid Surface		1163	1255	1387	1554
			Non-stocked (per color, per order)	ADD	410 NET	450 NET	490 NET	520 NET
<b>22 ROUND x 20.5H</b> DIA: 22 H: 20.5		<b>CMTLR-2220</b>	Stocked .5"-thick Solid Surface		1163	1255	1387	1554
			Non-stocked (per color, per order)	ADD	410 NET	450 NET	490 NET	520 NET
<b>28 ROUND x 17.5H</b> DIA: 28 H: 17.5		<b>CMTLR-2817</b>	Stocked .5"-thick Solid Surface		1427	1547	1723	1961
			Non-stocked (per color, per order)	ADD	410 NET	450 NET	490 NET	520 NET
<b>28 ROUND x 20.5H</b> DIA: 28 H: 20.5		<b>CMTLR-2820</b>	Stocked .5"-thick Solid Surface		1427	1547	1723	1961
			Non-stocked (per color, per order)	ADD	410 NET	450 NET	490 NET	520 NET



# INTEGRA | STOCKED FINISHES

## SOLID SURFACE | STOCKED OPTIONS

INTEGRASEATING.COM/FINISHES

### GRADE

<b>A</b>	<b>LG HI-MACS</b>	Arctic White, Cream, Almond Pearl
<b>B</b>	<b>LG HI-MACS</b>	Allspice Quartz, Venetian Sand, Desert Sand
<b>C</b>	<b>LG HI-MACS</b>	Glitz, Gray, Haze
<b>D</b>	<b>CORIAN</b>	Deep Titanium, Deep Sable, Weathered Concrete

## METAL FINISH | STANDARD OPTIONS

<b>POWDER COAT</b>	Glacier	<b>CX</b>	Bronze	<b>ZX</b>	BRUSHED CHROME	<b>BC</b>
	Chalk	<b>HX</b>	Bark	<b>KX</b>	BRUSHED ALUMINUM	<b>BA</b>
	Cement	<b>MX</b>	Slate	<b>SX</b>		
	Silver	<b>VX</b>	Onyx	<b>BX</b>		
	Fossil	<b>FX</b>				

**NOTE: See each series for available standards.**

## WOOD FINISH | STANDARD OPTIONS

HARD MAPLE

<b>INSPIRED COLORS</b>	Sugar	Pewter Mist	<b>ORIGINAL COLORS</b>	Vanilla	Saffron
	Sea Salt	Poppy Seed		Ginger	Chili
	Almond	Hazelnut		Cinnamon	Clove
	Jasmine	Mocha		Nutmeg	Pepper

**NOTE: Custom Wood Finishes are available at a one-time upcharge of \$300 Net per color. Contact your customer service representative for more details.**

## STOCKED LAMINATE OPTIONS FOR WOOD FINISHES

INSPIRED WOOD FINISH	HPL MANUFACTURER	NAME/PATTERN	ID#	ORIGINAL WOOD FINISH	HPL MANUFACTURER	NAME/PATTERN	ID#
Sugar	Wilsonart	Phantom Pearl	8211K-28	Vanilla	Pionite	Hardrock Maple	WM791-S
Sea Salt (opt. 1)	Wilsonart	Asian Sand	7952K-18	Ginger	Pionite	Millwork Cherry	WC431-PV
Sea Salt (opt. 2)	Wilsonart	Wallaby	D439-60	Cinnamon	Nevamar	Blossom Cherry	WC5581N
Almond	Wilsonart	Raw Chestnut	7975K-12	Nutmeg	Wilsonart	Cherrywood	11062K-07
Jasmine	Nevamar	Beige Renaissance	WM8258-T	Saffron	Wilsonart	Judicial Walnut	11065K-07
Pewter Mist	Nevamar	Luminary Teak	WT0005T	Chili	Wilsonart	Empire Mahogany	7122K-07
Poppy Seed (opt. 1)	Formica	Silver Riftwood	6413-NG	Clove	Wilsonart	Cafelle	7933K-07
Poppy Seed (opt. 2)	Pionite	Absolute Acajou	WY160-SD	Clove (alt)	Wilsonart	Cocobala	7942K-07
Poppy Seed (opt. 3)	Wilsonart	Phantom Cocoa	8213K-28	Pepper	Wilsonart	Black	1595K-07
Poppy Seed (opt. 4)	Wilsonart	Skyline Walnut	7964K-12				
Hazelnut (opt. 1)	Wilsonart	Studio Teak	7960K-18				
Hazelnut (opt. 2)	Pionite	Pralines & Cream	WW160-SD				
Mocha (opt. 1)	Wilsonart	Hampton Walnut	7959K-78				
Mocha (opt. 2)	Formica	Cocoa Maple	7739-58				
Mocha (opt. 3)	Pionite	Gunstock Savoy Walnut	WW971-SD				

**NOTE: Non-Stocked Laminate selections incur a \$50 Net charge per color, per order.**





## ORDERING & SPECIFICATIONS

### HOW TO USE THIS PRICE LIST

Each series or collection has the available options within that series. Available options may include: legs/bases, arm caps, seats, tablets, power, and other product options. Please see each series for the available options, details, and pricing.

Integra's PDF price list has links from the Table of Contents to each section for easier movement through the document. Also, at the top of each page is an icon that will take you back to the Table of Contents page.

And of course, our exceptional Customer Service Team is happy to help you with quotes, product questions and anything else you need to work with Integra products!

### GENERAL ORDERING INFORMATION

Direct all orders to: **INTEGRA, INC.**  
PO BOX M  
807 Wisconsin Street  
Walworth, WI 53184  
(800) 235-0234 (262) 275-2161 (262) 275-3614 FAX  
orderentry@integraseating.com

When placing an order, please be sure to include ALL of the following:

- Your Company Name, Address, Telephone, Fax and Email Address
- Contact Person for Order and Email Address
- Purchase Order Number, Bill To Address, Ship to Address, Order Date
- Integra Quote Number, if Integra provided a Quote
- Quantity
- Product Code/Number
- Product Description
- Selected Options
- Fabric: Pattern and Color
- Wood Species
- Wood Finish
- Line Drawings for System Orders
- Requested Ship Date
- Any Special Instructions

#### ORDERS & ORDER CONFIRMATION:

Orders may be received via fax, mail or emailed to customerservice@integraseating.com. Acknowledgments will be emailed. Changes in the ship to address after order entry will incur additional charges.

#### CHANGE ORDERS AND CANCELLATIONS:

Written changes on orders or cancellations of orders will only be accepted within 48 hours after receipt of order.

#### PRICES:

Published prices are List F.O.B. destination on shipments over \$7,500 List and within the Contiguous U.S. Shipments under \$7,500 List will incur a \$300 NET freight charge. Integra prefers to ship furniture set-up at the factory and blanket-wrapped. In certain instances, furniture will be packaged in cartons and shipped; cartoning charges may apply.

Prices do not include:

- storage or insurance charges
- sales or other taxes
- multiple deliveries, uncartoning, assembly, or installation

#### TERMS OF PAYMENT:

Orders require prepayment upon placement of original order, balance required prior to shipment. Terms for accredited customers are NET 30. Integra may request advance payment at any time. A service charge for any special handling may be assessed. A service charge of 1.5% per month will be assessed on unpaid balance of all past due accounts.

#### RETURNS:

No returns of furniture will be accepted without our written consent and shipping instructions. Special order items are not subject to return.

### DESIGN AND SPECIFICATIONS

Integra reserves the right to alter product design for purposes at our discretion including: construction and material improvements, pricing or dimension corrections, and other purposes without notification. All dimensions shown are approximate. If critical specifications are required, please consult the factory.

#### GENERAL PRODUCT SPECIFICATIONS:

Integra's products listed in this contract price list include these features:

- High Resilience Foam in All Seat Units
- No-spring Dymetrol Suspension System in all seating that uses a suspension system
- 16 Gauge Steel Tubular Inner Structure and Assembly Patented to Integra
- All Integra chairs and seating units have a 1000 lbs dynamic load capacity and a 2000 lbs static load capacity.
- Product specifications for all product lines are available upon request

#### CUSTOM PRODUCT DESIGN & ENGINEERING:

Integra tries to accommodate custom request to best meet the needs of our customers. Please bring custom requests to our Project Management Team. They will work with our Engineering Team for review and approval. **If approved, most custom requests will incur a \$300 NET Custom Engineering Fee.** If the custom request involves a significant amount of custom design and engineering that charge may be increased. Our team will notify the requestor of any increase in charges.

#### LIFETIME WARRANTY:

Products manufactured by Integra after October, 1 2007 are warranted to be free of defects in material and workmanship under normal use for the lifetime of the product. Product must be properly assembled, maintained and in use by its original owner. Under the warranty, the obligation of Integra is limited to the repair or replacement of such furniture. Damage in transit or by negligence, abuse, abnormal usage, misuse, accidents or alterations nullifies the warranty.

As Buyer's sole remedy under this warranty, Integra, at its option, will repair or replace damaged parts at no charge to the original owner of record provided the replacement or return has previously been authorized by Integra under terms of this warranty. Normal aging and wear of fabrics, filling materials, and finishes are excepted from this warranty. Any labor charges incurred will be at the Buyer's expense. It is expressly agreed that this remedy of repair, replacement or credit, at Integra's option, is Buyer's exclusive remedy under this warranty. In no event shall Seller be liable for consequential damages.

All other express or implied warranties made by any sales representative, or agent, or other representative, including any warranty of merchantability or fitness for a particular use, are hereby excluded. A-Chairs carry a 10 year warranty. Electric Power Ports carry a one year warranty.

#### FABRICS:

In order to fit the wide range of our customer's needs, Integra currently has partnerships and graded-in programs with these textile companies:

Anzea	www.anzea.com	877.862.6932
Arc-Com	www.arc-com.com	800.223.5466
Architex	www.architex-ljh.com	800.621.0827
Camira	www.camirafabrics.com	616.288.0655
CF Stinson	www.cfstinson.com	800.841.6279
DesignTex	www.designtex.com	800.221.1540
EnviroLeather by LDI	www.ldiinteriors.com	866.332.0700
Maharam	www.maharam.com	800.645.3943
Mayer	www.mayerfabrics.com	800.428.4415
Momentum	www.memosamples.com	800.366.6839
UltraFabrics	www.ultrafabricsinc.com	877.309.6648

For a listing of the current graded-in fabrics and grades, visit our website at [integraseating.com/fabrics](http://integraseating.com/fabrics).



## DESIGN AND SPECIFICATIONS (CONTINUED)

Integra offers a wide range of fabrics to our customers in our graded-in program. Integra does not stock fabric; all textiles are ordered from the distributor at the time we receive an order. Integra is not responsible for differences in color between material supplied and samples from which choices have been made, nor is Integra responsible for matching upholstery on existing product to any future orders. **Please note that Integra does not warranty fabrics and is not responsible for any replacement fabric, covers, or re-upholstery labor costs for failed fabrics whether graded-in or sent to us as a COM/COL. We can provide a quote for new covers at the time needed. Please contact the fabric companies for any warranty information on their own products.**

### COMBINATION FABRICS (Simple and Complex):

More than one fabric may be specified and applied to the same product. Integra does not upcharge for simple fabric combinations which consist of one fabric each on a component (i.e. seat, back, arm, or front panel). For simple combinations, the price is typically based upon the highest fabric grade of the chosen fabrics on the product. Complex fabric combinations consist of multiple fabrics on a single component, such as the front of the back in Fabric A and the back of the back is in Fabric B. Complex combinations will incur a 5% upcharge. Fabric combination forms are required at the time of order. Contact Customer Service for fabric combination forms or assistance.

### FABRIC APPLICATION:

Standard procedure is for Integra to match all fabrics that require matching such as plaids, prints, or stripes. If matching is not desired, this must be clearly noted on the purchase order. Integra will apply textiles to upholstered items in the manner which we deem to be the most appealing.

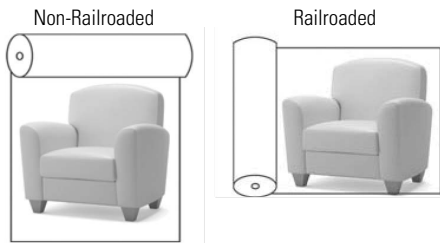

Standard procedure is for Integra to cut all fabrics non-railroaded unless otherwise clearly specified on the purchase order. See the diagrams above for a visual description of non-railroaded vs railroaded applications. To ensure correct cutting and application of the fabric, it is suggested that a clearly marked sample is sent with the purchase order when requesting a non-standard application of the fabric. Please note that when railroading fabric, it is possible that additional yardage may be required. Integra assumes no responsibility for the direction in which the textiles are applied unless it is clearly specified on the purchase order.

### FABRIC REPEATS:

**Fabric with larger repeats or smaller roll widths may require additional fabric than what is noted in the price list. Standard upholstery textile rolls are 54-inch wide. The yardage amounts noted are based upon 54-inch wide textiles without a pattern repeat.** For calculating additional yardage due to pattern repeat or a roll less than 54" wide, see chart below to match roll width with repeat amount. For the specific textile, with both the vertical & horizontal repeat measurements, use the larger of the two repeats then use the chart below for additional yardage requirements. Add the required additional % to the COM yardage amount noted in the current Integra Price List for total yardage needed per furniture item.

UPH. TEXTILE ROLL WIDTH	SOLID NO REPEAT	REPEAT OF 2"-14"	REPEAT OF 15"-19"	REPEAT OF 20"-27"	REPEAT OF 28"-36"
54"	0%	10%	15%	20%	25%
50" - 53"	16%	20%	25%	30%	35%
48"	16%	25%	30%	35%	40%
45"	40%	50%	55%	60%	65%
36"	50%	60%	65%	70%	75%

Contact Integra Customer Service at 800-235-0234 x4 with any questions.

For graded-in fabrics, this additional fabric yardage will be noted and charged as a separate line on the quotation, sales order, and invoice.

## DESIGN AND SPECIFICATIONS (CONTINUED)

### CUSTOMER'S OWN MATERIAL (C.O.M.) POLICY:

Integra will work with customer's own material with approval. A memo sample of the fabric must be sent to the factory before the fabric can be approved for upholstery purposes only; this approval is NOT an indicator of how it will perform in the field. Following approval, you will be advised of any additional yardage which may be required for your order and any upcharges for special handling and/or hand cutting. COM combo yardage will increase yardage. Contact Customer Service for combo yardage summary. COM yardage estimates are based upon 54-inch wide textiles without pattern repeat. **COM must be on one continuous roll or the same dye lot and consistent repeat.** A memo sample of your fabric should accompany the purchase order to properly identify your fabric when it arrives at the factory.

Please note that all C.O.M. fabrics must ship freight prepaid (collect shipments will not be accepted) and should be properly labeled for your order. Ship to:

Integra, Inc.  
Tag for: (Your PO# of the order it is to be applied to)  
810 Wisconsin Street  
Walworth, WI 53184

The prices shown for COM include the product and only the labor for the fabric's application. The cost of fabric and freight costs to ship the fabric is the customer's responsibility. The performance of any fabric is the responsibility of the fabric supplier. Integra does not offer any warranty to fabrics. While we inspect fabrics for mill imperfections, some are difficult to recognize. We cannot be responsible for defects, color inaccuracies, dye lot variations, and other flaws. Under no circumstances will Integra assume responsibility for COM/COL shortages, flaws, or other such problems. While we make a concerted effort to control COM/COL materials, it is not our responsibility to monitor the receipt of these materials in order to meet delivery deadlines and we assume that customers are aware of any undue delay in delivery of their COM/COL materials.

**Integra does not warranty fabrics and is not responsible for any replacement fabric, covers, or re-upholstery labor costs for failed fabrics whether graded-in or sent to us as a COM/COL. We can provide a quote for new covers at the time needed. Please contact the fabric companies for any warranty information on their own products.**

### WOOD FINISHES AND WOOD SPECIES:

Integra cannot be responsible for differences in color or tone between the finish sample and final finished product. This difference is due to the variations in natural material and finish surface size.

Standard Wood Species: Hard Maple

### Original Wood Finishes

- Vanilla
- Ginger
- Cinnamon
- Nutmeg
- Saffron
- Chili
- Clove
- Pepper

### Inspired Colors Wood Finishes

- Sugar
- Sea Salt
- Almond
- Jasmine
- Pewter Mist
- Poppy Seed
- Hazelnut
- Mocha

### CUSTOM WOOD FINISH (CWF):

Integra will accept custom finish orders. This could extend lead time. There is a \$300 NET flat fee upcharge for custom finish orders. An additional upcharge is possible depending on stain. Paint finish will not be accepted. Send a wood sample which will be matched and returned to you for sign off approval. When the approval is received by Integra, the order will be entered into production. Custom wood finishes are valid for a minimum of 2 years.

### METAL POWDER COAT FINISHES:

- Glacier
- Chalk
- Cement
- Silver
- Fossil
- Bronze
- Bark
- Slate
- Onyx



## DESIGN AND SPECIFICATIONS (CONTINUED)

### LAMINATE:

On many Integra Tables, Table Arms, and Arm Caps, laminate is a top option. Please see each series for availability. Pricing for laminates falls into the following categories:

#### Stocked Laminates

Integra has chosen specific laminates to match our standard wood finishes where possible. Contact Customer Service for a list of standard laminates. See LAM Price in Price List.

#### Other Laminates

Any laminate not in our stocked program, including custom or premium, will incur a \$50 NET flat fee upcharge per laminate selection on each order. Orders with custom laminate or special finishes may have extended lead times.

### SOLID SURFACE:

Stocked Solid Surfaces: See current listing of Stocked Solid Surfaces

Non-Stocked Solid Surfaces: Upcharges will apply

### MOISTURE BARRIER:

A moisture barrier option is available for all styles of Integra seat units. A polyurethane layer is placed between the fabric and the foam to protect the foam from any moisture. There is an upcharge for this option; please see Product Options in each series for availability, current pricing and yardage requirements per item. Moisture Barrier may telegraph through thinner textiles.

### CALIFORNIA TB 117 AND 133 COMPLIANCE:

All Integra products with standard fabrics pass CA TB 117 fire code requirements, and are able to pass CA TB 133 using approved fabric and **fire wall**. Contact factory for information regarding approved fabrics which meet the requirements of this technical bulletin. Application of **fire wall** for TB 133 compliance requires an upcharge; see Product Options in each series for availability, current pricing and yardage requirements per item. We cannot be responsible for flame retardancy of C.O.M. fabrics; please consult published technical data of fabric suppliers. NOTE: CA TB 133 option not available with leather.

## PACKAGING & SHIPPING

### FREIGHT:

Shipments to AZ, NM, CA, OR, WA, ID, MT & NV over \$10,000 List include freight charges. Shipments to all other states within the Contiguous US over \$7,500 List include freight charges. Please note that cartoned shipments can incur additional expenses from our freight carriers. Please contact Integra Customer Service for upcharges.

Shipments made outside the Contiguous United States will be cartoned and shipped to the Port of Exit. Cartoning charges will apply; customer is responsible for freight charges from the Port of Exit to the final destination.

Integra's standard method is to set-up and blanket wrap furniture for shipping. This requires coordination with the freight company in order to meet and unload the truck at the destination. Furniture is assembled and will need to be inspected and set in place.

Integra will require receiving information at the time of the order and will advise estimated unloading time allotted for delivery. A loading dock to accommodate a 53' trailer is required for all shipments from Integra. Please note, improper loading dock at receiving point, lack of appropriate personnel to unload product and/or excessive unloading time will incur additional charges.

At time of delivery, blankets are removed and returned with driver. Inspection & damage must be noted within time allotted for unloading.

Should the freight company discover improper loading dock or inadequate personnel for unloading at time of delivery, the freight carrier reserves the right to have freight returned; this will incur reconsignment and reshipping charges which will be billed to the customer's account and will be due before the 2nd delivery attempt.

### SPECIFIC DATE DELIVERY:

If a shipment requires a specific day of delivery or time-specific delivery, additional charges will be applied by the freight company which will be added to your invoice. Shipments to New York City and Washington DC metro areas will also incur additional expenses from our freight carriers. Please contact Customer Service for upcharges.

### CARTON CHARGES:

In certain cases, and as an option, we can carton our furniture for shipping. The following cartoning charges will apply:

Carton Charges: \$35 NET per chair; \$50 NET per settee; \$65 NET per sofa. Tables: \$35 NET up to 24x24x24 in size; \$50 NET up to 36x36x36 in size and all oval, half oval and rectangular tables. 42x42 and 48x48 tables will be blanket-wrapped only; they cannot be cartoned. Please note that cartoned shipments can incur additional expenses from our freight carriers. Please contact Integra Customer Service for upcharges.

### MINIMUM ORDER FREIGHT CHARGE:

Shipments to AZ, NM, CA, OR, WA, ID, MT & NV under \$10,000 List will incur a \$500 NET Freight Charge. Shipments to all other states within the Contiguous US under \$7,500 List will incur a \$300 NET Freight Charge.

### FREIGHT DAMAGE CLAIMS:

All Integra products are carefully inspected prior to shipment from the factory. Title to products is passed to the purchaser and Integra's responsibility ceases when the shipment is accepted for transportation by a carrier. Freight claims are the responsibility of the customer. All shipments should be carefully inspected before acceptance and the customer MUST record any damage on both copies of the freight bill, signed by the customer and the driver. Concealed damage reports must be made to the carrier within 10 days after delivery or the carrier will not be responsible. All packing materials involved in a damage claim must be saved in their original condition until they have been inspected by the proper agent.

### STORAGE:

If a customer is unable to accept delivery of merchandise when Integra is ready to make a shipment, Integra reserves the right to transfer merchandise to storage. Transfer to storage and storage charges will be at customer's expense. Transfer to storage shall constitute delivery for all intents and purposes, including invoicing and payment.