

## TABLE COLLECTIONS

|                                  |             |
|----------------------------------|-------------|
| A-TABLES                         | ITC 2 - 7   |
| CUBE TABLES WITH SELF EDGE       | ITC 8 - 10  |
| DRUM TABLES WITH SELF EDGE       | ITC 11 - 13 |
| CUBE TABLES WITH SOLID WOOD EDGE | ITC 14 - 16 |
| DRUM TABLES WITH SOLID WOOD EDGE | ITC 17 - 19 |
| KIXSY PULL-UP TABLE              | ITC 20      |

## OTHER TABLES IN THEIR RESPECTIVE COLLECTION

|                      |             |
|----------------------|-------------|
| ALPINE TABLES        | ALC 14 - 24 |
| COASTAL METAL TABLES | CCM 22 - 23 |
| KALLISE TABLES       | KLC 10 - 20 |
| PAX TABLES           | PLC 6 - 16  |
| VALAYO TABLES        | VC 4 - 5    |



# TABLE COLLECTIONS | A-TABLES

## SPECIFICATION INFORMATION

PLEASE USE THE FOLLOWING SEQUENCE WHEN SPECIFYING A-TABLES:

**1. ITEM NUMBER: ATB-F-MV4824SQ18(LL)**

The item number for each table is the combination of its wood species (M=Hard Maple), top size (48x24) and edge detail (SQ) followed by height (18) and leg style (LL).

**2. LAMINATE ITEM NUMBER: ATB-F-LM4824SQ18(LL)**

Add L to part #.

**3. EDGE DETAIL OPTION: (SQ)**

The edge option code is two letters corresponding to the following edge details.

**SQUARE (SQ)**

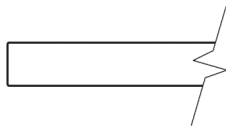

**4. LEG STYLE: (LL)**

Specify leg style. The leg style code is two letters corresponding to the following leg styles.

**TAPERED LEG (TL)**



**COASTAL LEG (CT)**



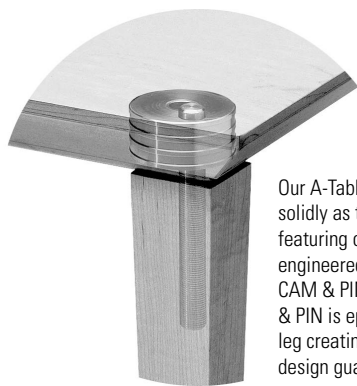
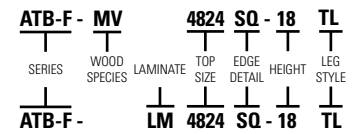

EXAMPLE:



Our A-Tables are built just as solidly as the rest of our products featuring our innovatively engineered and ultra-strong steel CAM & PIN connection. The CAM & PIN is epoxied to the top and leg creating a beautiful and clean design guaranteed to hold up.





A-TABLES - ROUND

|  |   | MODEL                       | TOP (1.5"-THICK) | HARD MAPLE<br>TL, CT |
|--|---|-----------------------------|------------------|----------------------|
| <b>18 ROUND x 18H</b><br>DIA: 18 H: 18 |  | <b>ATB-F-MV18DSQ-18(LL)</b> | Maple Veneer     | 1308                 |
|  |   | <b>ATB-F-LM18DSQ-18(LL)</b> | Stocked Laminate | 1308                 |
| <b>18 ROUND x 21H</b><br>DIA: 18 H: 21 |  | <b>ATB-F-MV18DSQ-21(LL)</b> | Maple Veneer     | 1368                 |
|  |   | <b>ATB-F-LM18DSQ-21(LL)</b> | Stocked Laminate | 1368                 |
| <b>18 ROUND x 24H</b><br>DIA: 18 H: 24 |  | <b>ATB-F-MV18DSQ-24(LL)</b> | Maple Veneer     | 1412                 |
|  |   | <b>ATB-F-LM18DSQ-24(LL)</b> | Stocked Laminate | 1412                 |

Add SOLID SURFACE ONLY price to Veneer price above

| 18 DIA SOLID SURFACE ONLY UPCHARGE | A           | B        | C        | D        |
|------------------------------------|-------------|----------|----------|----------|
| Stocked                            | 636 LIST    | 636 LIST | 712 LIST | 785 LIST |
| Non-stocked (per color, per order) | ADD 410 NET | 450 NET  | 490 NET  | 520 NET  |

**NOTE: 1/2" Solid Surface Onlay will increase overall height by 1/2".**

|  |   | MODEL                       | TOP (1.5"-THICK) | HARD MAPLE<br>TL, CT |
|--|---|-----------------------------|------------------|----------------------|
| <b>21 ROUND x 18H</b><br>DIA: 21 H: 18 |    | <b>ATB-F-MV21DSQ-18(LL)</b> | Maple Veneer     | 1400                 |
|  |   | <b>ATB-F-LM21DSQ-18(LL)</b> | Stocked Laminate | 1400                 |
| <b>21 ROUND x 21H</b><br>DIA: 21 H: 21 |   | <b>ATB-F-MV21DSQ-21(LL)</b> | Maple Veneer     | 1460                 |
|  |   | <b>ATB-F-LM21DSQ-21(LL)</b> | Stocked Laminate | 1460                 |
| <b>21 ROUND x 24H</b><br>DIA: 21 H: 24 |  | <b>ATB-F-MV21DSQ-24(LL)</b> | Maple Veneer     | 1504                 |
|  |   | <b>ATB-F-LM21DSQ-24(LL)</b> | Stocked Laminate | 1504                 |

Add SOLID SURFACE ONLY price to Veneer price above

| 21 DIA SOLID SURFACE ONLY UPCHARGE | A           | B        | C        | D         |
|------------------------------------|-------------|----------|----------|-----------|
| Stocked                            | 865 LIST    | 865 LIST | 966 LIST | 1069 LIST |
| Non-stocked (per color, per order) | ADD 410 NET | 450 NET  | 490 NET  | 520 NET   |

**NOTE: 1/2" Solid Surface Onlay will increase overall height by 1/2".**

**NON-STOCKED / CUSTOM  
FINISH UPCHARGES**

|  |     |         |
|--|-----|---------|
| Non-Stocked Laminate (per color, per order)  | ADD | 50 NET  |
| Custom Wood Finish (CWF) (one-time upcharge) | ADD | 300 NET |



# A-TABLES - ROUND

|  |  | MODEL                       | TOP (1.5"-THICK) | HARD MAPLE<br>TL, CT |
|--|--|-----------------------------|------------------|----------------------|
| <b>24 ROUND x 18H</b><br>DIA: 24 H: 18 |  | <b>ATB-F-MV24DSQ-18(LL)</b> | Maple Veneer     | 1503                 |
|  |  | <b>ATB-F-LM24DSQ-18(LL)</b> | Stocked Laminate | 1503                 |
| <b>24 ROUND x 21H</b><br>DIA: 24 H: 21 |  | <b>ATB-F-MV24DSQ-21(LL)</b> | Maple Veneer     | 1563                 |
|  |  | <b>ATB-F-LM24DSQ-21(LL)</b> | Stocked Laminate | 1563                 |
| <b>24 ROUND x 24H</b><br>DIA: 24 H: 24 |  | <b>ATB-F-MV24DSQ-24(LL)</b> | Maple Veneer     | 1607                 |
|  |  | <b>ATB-F-LM24DSQ-21(LL)</b> | Stocked Laminate | 1607                 |

Add SOLID SURFACE ONLAY price to Veneer price above

| 24 DIA SOLID SURFACE ONLAY UPCHARGE | A           | B         | C         | D         |
|-------------------------------------|-------------|-----------|-----------|-----------|
| Stocked                             | 1129 LIST   | 1129 LIST | 1263 LIST | 1395 LIST |
| Non-stocked (per color, per order)  | ADD 410 NET | 450 NET   | 490 NET   | 520 NET   |

**NOTE: 1/2" Solid Surface Onlay will increase overall height by 1/2".**

|  |  | MODEL                       | TOP (1.5"-THICK) | HARD MAPLE<br>TL, CT |
|--|--|-----------------------------|------------------|----------------------|
| <b>30 ROUND x 18H</b><br>DIA: 29.5 H: 18 |  | <b>ATB-F-MV30DSQ-18(LL)</b> | Maple Veneer     | 1750                 |
|  |  | <b>ATB-F-LM30DSQ-18(LL)</b> | Stocked Laminate | 1750                 |
| <b>30 ROUND x 21H</b><br>DIA: 29.5 H: 21 |  | <b>ATB-F-MV30DSQ-21(LL)</b> | Maple Veneer     | 1810                 |
|  |  | <b>ATB-F-LM30DSQ-21(LL)</b> | Stocked Laminate | 1810                 |
| <b>30 ROUND x 24H</b><br>DIA: 29.5 H: 24 |  | <b>ATB-F-MV30DSQ-24(LL)</b> | Maple Veneer     | 1854                 |
|  |  | <b>ATB-F-LM30DSQ-21(LL)</b> | Stocked Laminate | 1854                 |

Add SOLID SURFACE ONLAY price to Veneer price above

| 30 DIA SOLID SURFACE ONLAY UPCHARGE | A           | B         | C         | D         |
|-------------------------------------|-------------|-----------|-----------|-----------|
| Stocked                             | 1765 LIST   | 1765 LIST | 1972 LIST | 2181 LIST |
| Non-stocked (per color, per order)  | ADD 410 NET | 450 NET   | 490 NET   | 520 NET   |

**NOTE: 1/2" Solid Surface Onlay will increase overall height by 1/2".**

|  |  | MODEL                       | TOP (1.5"-THICK) | HARD MAPLE<br>TL, CT |
|--|--|-----------------------------|------------------|----------------------|
| <b>36 ROUND x 18H</b><br>DIA: 36 H: 18 |  | <b>ATB-F-MV36DSQ-18(LL)</b> | Maple Veneer     | 2061                 |
|  |  | <b>ATB-F-LM36DSQ-18(LL)</b> | Stocked Laminate | 2061                 |
| <b>36 ROUND x 21H</b><br>DIA: 36 H: 21 |  | <b>ATB-F-MV36DSQ-21(LL)</b> | Maple Veneer     | 2121                 |
|  |  | <b>ATB-F-LM36DSQ-21(LL)</b> | Stocked Laminate | 2121                 |
| <b>36 ROUND x 24H</b><br>DIA: 36 H: 24 |  | <b>ATB-F-MV36DSQ-24(LL)</b> | Maple Veneer     | 2165                 |
|  |  | <b>ATB-F-LM36DSQ-24(LL)</b> | Stocked Laminate | 2165                 |

Add SOLID SURFACE ONLAY price to Veneer price above

| 36 DIA SOLID SURFACE ONLAY UPCHARGE | A           | B         | C         | D         |
|-------------------------------------|-------------|-----------|-----------|-----------|
| Stocked                             | 2542 LIST   | 2542 LIST | 2840 LIST | 3140 LIST |
| Non-stocked (per color, per order)  | ADD 410 NET | 450 NET   | 490 NET   | 520 NET   |



**NOTE: 1/2" Solid Surface Onlay will increase overall height by 1/2".**

## NON-STOCKED / CUSTOM FINISH UPCHARGES

|  |     |         |
|--|-----|---------|
| Non-Stocked Laminate (per color, per order)  | ADD | 50 NET  |
| Custom Wood Finish (CWF) (one-time upcharge) | ADD | 300 NET |





# A-TABLES - SQUARE

|  |   | MODEL                         | TOP (1.5"-THICK) | HARD MAPLE<br>TL, CT |
|--|---|-------------------------------|------------------|----------------------|
| <b>18 SQUARE x 18H</b><br>W: 18 D: 18<br>H: 18 |  | <b>ATB-F-MV1818SQ-18(LL)</b>  | Maple Veneer     | 1215                 |
|  |   | <b>ATB-F-LM1818SQ-18(LL)</b>  | Stocked Laminate | 1215                 |
| <b>18 SQUARE x 21H</b><br>W: 18 D: 18<br>H: 21 |  | <b>ATB-F-MV1818SQ-21(LL)</b>  | Maple Veneer     | 1275                 |
|  |   | <b>ATB-F-LM1818SQ-21(LL)</b>  | Stocked Laminate | 1275                 |
| <b>18 SQUARE x 24H</b><br>W: 18 D: 18<br>H: 24 |  | <b>ATB-F-MV1818SQ-24(LL)</b>  | Maple Veneer     | 1319                 |
|  |   | <b>ATB-F-LM-1818SQ-24(LL)</b> | Stocked Laminate | 1319                 |

Add SOLID SURFACE ONLAY price to Veneer price above

| 18 x 18 SOLID SURFACE ONLAY UPCHARGE | A           | B        | C        | D        |
|--------------------------------------|-------------|----------|----------|----------|
| Stocked                              | 636 LIST    | 636 LIST | 712 LIST | 785 LIST |
| Non-stocked (per color, per order)   | ADD 410 NET | 450 NET  | 490 NET  | 520 NET  |



**NOTE: 1/2" Solid Surface Onlay will increase overall height by 1/2".**

|  |   | MODEL                        | TOP (1.5"-THICK) | HARD MAPLE<br>TL, CT |
|--|---|------------------------------|------------------|----------------------|
| <b>21 SQUARE x 18H</b><br>W: 21 D: 21<br>H: 18 |    | <b>ATB-F-MV2121SQ-18(LL)</b> | Maple Veneer     | 1290                 |
|  |   | <b>ATB-F-LM2121SQ-18(LL)</b> | Stocked Laminate | 1290                 |
| <b>21 SQUARE x 21H</b><br>W: 21 D: 21<br>H: 21 |    | <b>ATB-F-MV2121SQ-21(LL)</b> | Maple Veneer     | 1350                 |
|  |   | <b>ATB-F-LM2121SQ-21(LL)</b> | Stocked Laminate | 1350                 |
| <b>21 SQUARE x 24H</b><br>W: 21 D: 21<br>H: 24 |  | <b>ATB-F-MV2121SQ-24(LL)</b> | Maple Veneer     | 1394                 |
|  |   | <b>ATB-F-LM2121SQ-24(LL)</b> | Stocked Laminate | 1394                 |

Add SOLID SURFACE ONLAY price to Veneer price above

| 21 x 21 SOLID SURFACE ONLAY UPCHARGE | A           | B        | C        | D         |
|--------------------------------------|-------------|----------|----------|-----------|
| Stocked                              | 865 LIST    | 865 LIST | 966 LIST | 1069 LIST |
| Non-stocked (per color, per order)   | ADD 410 NET | 450 NET  | 490 NET  | 520 NET   |

**NOTE: 1/2" Solid Surface Onlay will increase overall height by 1/2".**

|  |   | MODEL                        | TOP (1.5"-THICK) | HARD MAPLE<br>TL, CT |
|--|---|------------------------------|------------------|----------------------|
| <b>24 SQUARE x 18H</b><br>W: 24 D: 24<br>H: 18 |  | <b>ATB-F-MV2424SQ-18(LL)</b> | Maple Veneer     | 1454                 |
|  |   | <b>ATB-F-LM2424SQ-18(LL)</b> | Stocked Laminate | 1454                 |
| <b>24 SQUARE x 21H</b><br>W: 24 D: 24<br>H: 21 |  | <b>ATB-F-MV2424SQ-21(LL)</b> | Maple Veneer     | 1514                 |
|  |   | <b>ATB-F-LM2424SQ-21(LL)</b> | Stocked Laminate | 1514                 |
| <b>24 SQUARE x 24H</b><br>W: 24 D: 24<br>H: 24 |  | <b>ATB-F-MV2424SQ-24(LL)</b> | Maple Veneer     | 1558                 |
|  |   | <b>ATB-F-LM2424SQ-24(LL)</b> | Stocked Laminate | 1558                 |

Add SOLID SURFACE ONLAY price to Veneer price above

| 24 x 24 SOLID SURFACE ONLAY UPCHARGE | A           | B         | C         | D         |
|--------------------------------------|-------------|-----------|-----------|-----------|
| Stocked                              | 1129 LIST   | 1129 LIST | 1263 LIST | 1395 LIST |
| Non-stocked (per color, per order)   | ADD 410 NET | 450 NET   | 490 NET   | 520 NET   |







**NOTE: 1/2" Solid Surface Onlay will increase overall height by 1/2".**

## NON-STOCKED / CUSTOM FINISH UPCHARGES

|  |     |         |
|--|-----|---------|
| Non-Stocked Laminate (per color, per order)  | ADD | 50 NET  |
| Custom Wood Finish (CWF) (one-time upcharge) | ADD | 300 NET |









# A-TABLES - SQUARE

|  |   | MODEL   | TOP (1.5"-THICK)      | HARD MAPLE<br>TL, CT  |
|--|---|---|-----------------------|-----------------------|
| <b>30 SQUARE x 18H</b><br>W: 29.5 D: 29.5<br>H: 18 |  |  | ATB-F-MV3030SQ-18(LL) | Maple Veneer 1686     |
|  |   |   | ATB-F-LM3030SQ-18(LL) | Stocked Laminate 1686 |
| <b>30 SQUARE x 21H</b><br>W: 29.5 D: 29.5<br>H: 21 |  |  | ATB-F-MV3030SQ-21(LL) | Maple Veneer 1746     |
|  |   |   | ATB-F-LM3030SQ-21(LL) | Stocked Laminate 1746 |
| <b>30 SQUARE x 24H</b><br>W: 29.5 D: 29.5<br>H: 24 |  |  | ATB-F-MV3030SQ-24(LL) | Maple Veneer 1790     |
|  |   |   | ATB-F-LM3030SQ-24(LL) | Stocked Laminate 1790 |

Add SOLID SURFACE ONLAY price to Veneer price above

| 30 x 30 SOLID SURFACE ONLAY UPCHARGE | A           | B         | C         | D         |
|--------------------------------------|-------------|-----------|-----------|-----------|
| Stocked                              | 1765 LIST   | 1765 LIST | 1972 LIST | 2181 LIST |
| Non-stocked (per color, per order)   | ADD 410 NET | 450 NET   | 490 NET   | 520 NET   |

**NOTE: 1/2" Solid Surface Onlay will increase overall height by 1/2".**

|  |   | MODEL   | TOP (1.5"-THICK)      | HARD MAPLE<br>TL, CT  |
|--|---|---|-----------------------|-----------------------|
| <b>36 SQUARE x 18H</b><br>W: 36 D: 36<br>H: 18 |    |    | ATB-F-MV3636SQ-18(LL) | Maple Veneer 1957     |
|  |   |   | ATB-F-LM3636SQ-18(LL) | Stocked Laminate 1957 |
| <b>36 SQUARE x 21H</b><br>W: 36 D: 36<br>H: 21 |    |   | ATB-F-MV3636SQ-21(LL) | Maple Veneer 2017     |
|  |   |   | ATB-F-LM3636SQ-21(LL) | Stocked Laminate 2017 |
| <b>36 SQUARE x 24H</b><br>W: 36 D: 36<br>H: 24 |  |  | ATB-F-MV3636SQ-24(LL) | Maple Veneer 2061     |
|  |   |   | ATB-F-LM3636SQ-24(LL) | Stocked Laminate 2061 |

Add SOLID SURFACE ONLAY price to Veneer price above

| 36 x 36 SOLID SURFACE ONLAY UPCHARGE | A           | B         | C         | D         |
|--------------------------------------|-------------|-----------|-----------|-----------|
| Stocked                              | 2542 LIST   | 2542 LIST | 2840 LIST | 3140 LIST |
| Non-stocked (per color, per order)   | ADD 410 NET | 450 NET   | 490 NET   | 520 NET   |

**NOTE: 1/2" Solid Surface Onlay will increase overall height by 1/2".**

## NON-STOCKED / CUSTOM FINISH UPCHARGES

|  |     |         |
|--|-----|---------|
| Non-Stocked Laminate (per color, per order)  | ADD | 50 NET  |
| Custom Wood Finish (CWF) (one-time upcharge) | ADD | 300 NET |

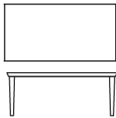

## A-TABLES - RECTANGLE

|  |   | MODEL                        | TOP (1.5"-THICK) | HARD MAPLE<br>TL, CT |
|--|---|------------------------------|------------------|----------------------|
| <b>46 x 21 RECTANGLE x 18H</b><br>W: 46 D: 21<br>H: 18 |  | <b>ATB-F-MV4621SQ-18(LL)</b> | Maple Veneer     | 1657                 |
|  |   | <b>ATB-F-LM4621SQ-18(LL)</b> | Stocked Laminate | 1657                 |

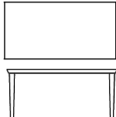
|  |   |                              |                  |      |
|--|---|------------------------------|------------------|------|
| <b>46 x 21 RECTANGLE x 21H</b><br>W: 46 D: 21<br>H: 21 |  | <b>ATB-F-MV4621SQ-21(LL)</b> | Maple Veneer     | 1717 |
|  |   | <b>ATB-F-LM4621SQ-21(LL)</b> | Stocked Laminate | 1717 |

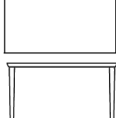
|  |   |                              |                  |      |
|--|---|------------------------------|------------------|------|
| <b>46 x 21 RECTANGLE x 24H</b><br>W: 46 D: 21<br>H: 24 |  | <b>ATB-F-MV4621SQ-24(LL)</b> | Maple Veneer     | 1787 |
|  |   | <b>ATB-F-LM4621SQ-24(LL)</b> | Stocked Laminate | 1787 |

| 46 x 21 SOLID SURFACE ONLAY UPCHARGE | Add SOLID SURFACE ONLAY price to Veneer price above |           |           |           |
|--------------------------------------|---|-----------|-----------|-----------|
|                                      | A   | B         | C         | D         |
| Stocked                              | 2259 LIST   | 2259 LIST | 2526 LIST | 2791 LIST |
| Non-stocked (per color, per order)   | ADD 410 NET   | 450 NET   | 490 NET   | 520 NET   |

**NOTE: 1/2" Solid Surface Onlay will increase overall height by 1/2".**

|  |  |     |         |
|--|--|-----|---------|
| <b>NON-STOCKED / CUSTOM<br/>FINISH UPCHARGES</b> | Non-Stocked Laminate (per color, per order)  | ADD | 50 NET  |
|  | Custom Wood Finish (CWF) (one-time upcharge) | ADD | 300 NET |

### PRODUCT OPTIONS

**PERMA-COAT WOOD LEG PROTECTOR** \$38 List / Leg



CUBE WITH SELF EDGE

HARD MAPLE OR LAMINATE

|   | MODEL                    | TOP              | PLINTH BASE<br>VP, LP, BP, NB | BLACK METAL PLINTH<br>MP | WOOD/ALUM LEGS<br>CW, BA | METAL LEGS<br>BC, BM |
|---|--------------------------|------------------|-------------------------------|--------------------------|--------------------------|----------------------|
| <b>18 SQUARE x 18H</b><br>W: 18 D: 18 H: 18 | <b>CV1-1818SQ-18-(_)</b> | Maple Veneer     | 2037                          | 2203                     | 2133                     | 2329                 |
|   | <b>CL1-1818SQ-18-(_)</b> | Stocked Laminate | 1629                          | 1795                     | 1725                     | 1921                 |
| <b>18 SQUARE x 21H</b><br>W: 18 D: 18 H: 21 | <b>CV1-1818SQ-21-(_)</b> | Maple Veneer     | 2180                          | 2346                     | 2276                     | 2472                 |
|   | <b>CL1-1818SQ-21-(_)</b> | Stocked Laminate | 1704                          | 1870                     | 1800                     | 1996                 |
| <b>18 SQUARE x 24H</b><br>W: 18 D: 18 H: 24 | <b>CV1-1818SQ-24-(_)</b> | Maple Veneer     | 2325                          | 2491                     | 2421                     | 2617                 |
|   | <b>CL1-1818SQ-24-(_)</b> | Stocked Laminate | 1758                          | 1924                     | 1854                     | 2050                 |

Add SOLID SURFACE ONLAY price to prices above

| 18 x 18 SOLID SURFACE ONLAY UPCHARGE | A           | B        | C        | D        |
|--------------------------------------|-------------|----------|----------|----------|
| Stocked                              | 636 LIST    | 636 LIST | 712 LIST | 785 LIST |
| Non-stocked (per color, per order)   | ADD 410 NET | 450 NET  | 490 NET  | 520 NET  |

**NOTE: 1/2" Solid Surface Onlay will increase overall height by 1/2".**

|                                      | MODEL         | DESCRIPTION                    | PRICE       |
|--------------------------------------|---------------|--------------------------------|-------------|
| <b>18 x 18 BOTTOM EDGE PROTECTOR</b> | <b>EPOC18</b> | For use with 18" Square Tables | ADD 94 LIST |

|   | MODEL                 | TOP              | PLINTH BASE<br>VP, LP, BP, NB | BLACK METAL PLINTH<br>MP | WOOD/ALUM LEGS<br>CW, BA | METAL LEGS<br>BC, BM |
|---|-----------------------|------------------|-------------------------------|--------------------------|--------------------------|----------------------|
| <b>24 SQUARE x 18H</b><br>W: 24 D: 24 H: 18 | <b>CV1-242418-(_)</b> | Maple Veneer     | 2489                          | 2690                     | 2557                     | 2753                 |
|   | <b>CL1-242418-(_)</b> | Stocked Laminate | 1880                          | 2081                     | 1948                     | 2144                 |
| <b>24 SQUARE x 21H</b><br>W: 24 D: 24 H: 21 | <b>CV1-242421-(_)</b> | Maple Veneer     | 2638                          | 2839                     | 2706                     | 2902                 |
|   | <b>CL1-242421-(_)</b> | Stocked Laminate | 1971                          | 2172                     | 2039                     | 2235                 |
| <b>24 SQUARE x 24H</b><br>W: 24 D: 24 H: 24 | <b>CV1-242424-(_)</b> | Maple Veneer     | 2843                          | 3044                     | 2911                     | 3107                 |
|   | <b>CL1-242424-(_)</b> | Stocked Laminate | 2048                          | 2249                     | 2116                     | 2312                 |

Add SOLID SURFACE ONLAY price to prices above

| 24 x 24 SOLID SURFACE ONLAY UPCHARGE | A           | B         | C         | D         |
|--------------------------------------|-------------|-----------|-----------|-----------|
| Stocked                              | 1129 LIST   | 1129 LIST | 1263 LIST | 1395 LIST |
| Non-stocked (per color, per order)   | ADD 410 NET | 450 NET   | 490 NET   | 520 NET   |

**NOTE: 1/2" Solid Surface Onlay will increase overall height by 1/2".**

|                                      | MODEL         | DESCRIPTION                    | PRICE        |
|--------------------------------------|---------------|--------------------------------|--------------|
| <b>24 x 24 BOTTOM EDGE PROTECTOR</b> | <b>EPOC24</b> | For use with 24" Square Tables | ADD 219 LIST |

**KEY FOR SPECIFYING CUBE TABLES:**

Replace ( ) in the product code with the following to specify legs/base. NOTE: Plinth Base Shown.

- VP or LP** 3"H Plinth Base with matching Veneer (VP) or Laminate (LP)
- BP** 3"H Plinth Base with Black Laminate
- MP** 3"H Black Metal Plinth Base
- CW** 5"H Hard Maple Legs (to match Coffee House Wood Legs)
- BC** 5"H Brushed Chrome Metal Legs
- BM** 5"H Powder Coated Metal Legs (specify Powder Coat)
- BA** 5"H Brushed Aluminum Legs (to match Coffee House Aluminum Legs)
- NB** No Base





**SELF EDGE  
DETAIL  
WITH SOLID  
SURFACE TOP**





**CUBE WITH SELF EDGE**



|                        |   |                       |                  | PLINTH BASE<br>VP, LP, BP, NB | BLACK METAL PLINTH<br>MP | WOOD/ALUM LEGS<br>CW, BA | METAL LEGS<br>BC, BM |
|------------------------|---|-----------------------|------------------|-------------------------------|--------------------------|--------------------------|----------------------|
| <b>30 SQUARE x 18H</b> |  | <b>CV1-303018-( )</b> | Maple Veneer     | 3189                          | 3505                     | 3232                     | 3428                 |
|                        |   | <b>CL1-303018-( )</b> | Stocked Laminate | 2183                          | 2499                     | 2226                     | 2422                 |
| <b>30 SQUARE x 21H</b> |  | <b>CV1-303021-( )</b> | Maple Veneer     | 3334                          | 3650                     | 3377                     | 3573                 |
|                        |   | <b>CL1-303021-( )</b> | Stocked Laminate | 2341                          | 2657                     | 2384                     | 2580                 |
| <b>30 SQUARE x 24H</b> |  | <b>CV1-303024-( )</b> | Maple Veneer     | 3433                          | 3749                     | 3476                     | 3672                 |
|                        |   | <b>CL1-303024-( )</b> | Stocked Laminate | 2436                          | 2752                     | 2479                     | 2675                 |

Add SOLID SURFACE ONLAY price to prices above

| 30 x 30 SOLID SURFACE ONLAY UPCHARGE | A           | B         | C         | D         |
|--------------------------------------|-------------|-----------|-----------|-----------|
| Stocked                              | 1765 LIST   | 1765 LIST | 1972 LIST | 2181 LIST |
| Non-stocked (per color, per order)   | ADD 410 NET | 450 NET   | 490 NET   | 520 NET   |

**NOTE: 1/2" Solid Surface Onlay will increase overall height by 1/2".**

|                                      | MODEL         | DESCRIPTION                    | PRICE        |
|--------------------------------------|---------------|--------------------------------|--------------|
| <b>30 x 30 BOTTOM EDGE PROTECTOR</b> | <b>EPOC30</b> | For use with 30" Square Tables | ADD 248 LIST |

|                        |   |                       |                  | PLINTH BASE<br>VP, LP, BP, NB | BLACK METAL PLINTH<br>MP | WOOD/ALUM LEGS<br>CW, BA | METAL LEGS<br>BC, BM |
|------------------------|---|-----------------------|------------------|-------------------------------|--------------------------|--------------------------|----------------------|
| <b>36 SQUARE x 18H</b> |    | <b>CV1-363618-( )</b> | Maple Veneer     | 3759                          | 4116                     | 3751                     | 3947                 |
|                        |   | <b>CL1-363618-( )</b> | Stocked Laminate | 2516                          | 2873                     | 2508                     | 2704                 |
| <b>36 SQUARE x 21H</b> |   | <b>CV1-363621-( )</b> | Maple Veneer     | 3856                          | 4213                     | 3848                     | 4044                 |
|                        |   | <b>CL1-363621-( )</b> | Stocked Laminate | 2697                          | 3054                     | 2689                     | 2885                 |
| <b>36 SQUARE x 24H</b> |  | <b>CV1-363624-( )</b> | Maple Veneer     | 4046                          | 4403                     | 4038                     | 4234                 |
|                        |   | <b>CL1-363624-( )</b> | Stocked Laminate | 2810                          | 3167                     | 2802                     | 2998                 |

Add SOLID SURFACE ONLAY price to prices above

| 36 x 36 SOLID SURFACE ONLAY UPCHARGE | A           | B         | C         | D         |
|--------------------------------------|-------------|-----------|-----------|-----------|
| Stocked                              | 2542 LIST   | 2542 LIST | 2840 LIST | 3140 LIST |
| Non-stocked (per color, per order)   | ADD 410 NET | 450 NET   | 490 NET   | 520 NET   |

**NOTE: 1/2" Solid Surface Onlay will increase overall height by 1/2".**

|                                      | MODEL         | DESCRIPTION                    | PRICE        |
|--------------------------------------|---------------|--------------------------------|--------------|
| <b>36 x 36 BOTTOM EDGE PROTECTOR</b> | <b>EPOC36</b> | For use with 36" Square Tables | ADD 355 LIST |

**NON-STOCKED / CUSTOM FINISH UPCHARGES**

|  |     |         |
|--|-----|---------|
| Non-Stocked Laminate (per color, per order)  | ADD | 50 NET  |
| Custom Wood Finish (CWF) (one-time upcharge) | ADD | 300 NET |

**KEY FOR SPECIFYING CUBE TABLES:**

Replace ( ) in the product code with the following to specify legs/base. NOTE: Plinth Base Shown.

- VP or LP** 3"H Plinth Base with matching Veneer (VP) or Laminate (LP)
- BP** 3"H Plinth Base with Black Laminate
- MP** 3"H Black Metal Plinth Base
- CW** 5"H Hard Maple Legs (to match Coffee House Wood Legs)
- BC** 5"H Brushed Chrome Metal Legs
- BM** 5"H Powder Coated Metal Legs (specify Powder Coat)
- BA** 5"H Brushed Aluminum Legs (to match Coffee House Aluminum Legs)
- NB** No Base



**SELF EDGE  
DETAIL  
WITH SOLID  
SURFACE TOP**



**ELECTRICAL / POWER PORT**

Power Ports are available on Cube tables; however, due to the many sizes and options available, a drawing will be required for each table (when sizes or placement vary) showing the Power Port location desired. Power Ports must be placed on a flat surface.

Tables will be subject to a custom engineering fee of \$300 NET for each different sized table or tables requiring different Power Port locations. Contact Integra Customer Service for Pricing.

**PRODUCT OPTIONS**

**PERMA-COAT WOOD LEG PROTECTOR** \$38 List / Leg



# TABLE COLLECTIONS | DRUMS

COMPONENT-BASED CONSTRUCTION

## DRUM WITH SELF EDGE

HARD MAPLE OR LAMINATE

|  |  | MODEL                | TOP              | PLINTH BASE<br>VP, LP, BP, NB | BLACK METAL PLINTH<br>MP | WOOD/ALUM LEGS<br>CW, BA | METAL LEGS<br>BC, BM |
|--|--|----------------------|------------------|-------------------------------|--------------------------|--------------------------|----------------------|
| <b>18 ROUND x 18H</b><br>DIA: 18 H: 18 |  | <b>DV1-18D18-( )</b> | Maple Veneer     | 1916                          | 2047                     | 2012                     | 2208                 |
|  |  | <b>DL1-18D18-( )</b> | Stocked Laminate | 1556                          | 1687                     | 1652                     | 1848                 |
| <b>18 ROUND x 21H</b><br>DIA: 18 H: 21 |  | <b>DV1-18D21-( )</b> | Maple Veneer     | 2037                          | 2168                     | 2133                     | 2329                 |
|  |  | <b>DL1-18D21-( )</b> | Stocked Laminate | 1604                          | 1735                     | 1700                     | 1896                 |
| <b>18 ROUND x 24H</b><br>DIA: 18 H: 24 |  | <b>DV1-18D24-( )</b> | Maple Veneer     | 2153                          | 2284                     | 2249                     | 2445                 |
|  |  | <b>DL1-18D24-( )</b> | Stocked Laminate | 1650                          | 1781                     | 1746                     | 1942                 |

Add SOLID SURFACE ONLAY price to prices above

| 18 DIA SOLID SURFACE ONLAY UPCHARGE | A           | B        | C        | D        |
|-------------------------------------|-------------|----------|----------|----------|
| Stocked                             | 636 LIST    | 636 LIST | 712 LIST | 785 LIST |
| Non-stocked (per color, per order)  | ADD 410 NET | 450 NET  | 490 NET  | 520 NET  |

**NOTE: 1/2" Solid Surface Onlay will increase overall height by 1/2".**

|                                     | MODEL         | DESCRIPTION                   | PRICE       |
|-------------------------------------|---------------|-------------------------------|-------------|
| <b>18 DIA BOTTOM EDGE PROTECTOR</b> | <b>EPOD18</b> | For use with 18" Round Tables | ADD 94 LIST |

|  |  | MODEL                | TOP              | PLINTH BASE<br>VP, LP, BP, NB | BLACK METAL PLINTH<br>MP | WOOD/ALUM LEGS<br>CW, BA | METAL LEGS<br>BC, BM |
|--|--|----------------------|------------------|-------------------------------|--------------------------|--------------------------|----------------------|
| <b>24 ROUND x 18H</b><br>DIA: 24 H: 18 |  | <b>DV1-24D18-( )</b> | Maple Veneer     | 2270                          | 2438                     | 2338                     | 2534                 |
|  |  | <b>DL1-24D18-( )</b> | Stocked Laminate | 1759                          | 1927                     | 1827                     | 2023                 |
| <b>24 ROUND x 21H</b><br>DIA: 24 H: 21 |  | <b>DV1-24D21-( )</b> | Maple Veneer     | 2377                          | 2545                     | 2445                     | 2641                 |
|  |  | <b>DL1-24D21-( )</b> | Stocked Laminate | 1833                          | 2001                     | 1901                     | 2097                 |
| <b>24 ROUND x 24H</b><br>DIA: 24 H: 24 |  | <b>DV1-24D24-( )</b> | Maple Veneer     | 2504                          | 2672                     | 2572                     | 2768                 |
|  |  | <b>DL1-24D24-( )</b> | Stocked Laminate | 1933                          | 2101                     | 2001                     | 2197                 |

Add SOLID SURFACE ONLAY price to prices above

| 24 DIA SOLID SURFACE ONLAY UPCHARGE | A           | B         | C         | D         |
|-------------------------------------|-------------|-----------|-----------|-----------|
| Stocked                             | 1129 LIST   | 1129 LIST | 1263 LIST | 1395 LIST |
| Non-stocked (per color, per order)  | ADD 410 NET | 450 NET   | 490 NET   | 520 NET   |

**NOTE: 1/2" Solid Surface Onlay will increase overall height by 1/2".**

|                                     | MODEL         | DESCRIPTION                   | PRICE        |
|-------------------------------------|---------------|-------------------------------|--------------|
| <b>24 DIA BOTTOM EDGE PROTECTOR</b> | <b>EPOD24</b> | For use with 24" Round Tables | ADD 140 LIST |

|  |  |             |
|--|--|-------------|
| <b>NON-STOCKED / CUSTOM FINISH UPCHARGES</b> | Non-Stocked Laminate (per color, per order)  | ADD 50 NET  |
|  | Custom Wood Finish (CWF) (one-time upcharge) | ADD 300 NET |

### KEY FOR SPECIFYING DRUM TABLES:

Replace ( ) in the product code with the following to specify legs/base. NOTE: Plinth Base Shown.

- VP or LP** 3"H Plinth Base with matching Veneer (VP) or Laminate (LP)
- BP** 3"H Plinth Base with Black Laminate
- MP** 3"H Black Metal Plinth Base
- CW** 5"H Hard Maple Legs (to match Coffee House Wood Legs)
- BC** 5"H Brushed Chrome Metal Legs
- BM** 5"H Powder Coated Metal Legs (specify Powder Coat)
- BA** 5"H Brushed Aluminum Legs (to match Coffee House Aluminum Legs)
- NB** No Base



**SELF EDGE  
DETAIL  
WITH SOLID  
SURFACE TOP**



## DRUM WITH SELF EDGE

|  |  | MODEL                | TOP              | PLINTH BASE<br>VP, LP, BP, NB | BLACK METAL PLINTH<br>MP | WOOD/ALUM LEGS<br>CW, BA | METAL LEGS<br>BC, BM |
|--|--|----------------------|------------------|-------------------------------|--------------------------|--------------------------|----------------------|
| <b>30 ROUND x 18H</b><br>DIA: 30 H: 18 |  | <b>DV1-30D18-( )</b> | Maple Veneer     | 2877                          | 3129                     | 2920                     | 3116                 |
|  |  | <b>DL1-30D18-( )</b> | Stocked Laminate | 2155                          | 2407                     | 2198                     | 2394                 |
| <b>30 ROUND x 21H</b><br>DIA: 30 H: 21 |  | <b>DV1-30D21-( )</b> | Maple Veneer     | 3077                          | 3329                     | 3120                     | 3316                 |
|  |  | <b>DL1-30D21-( )</b> | Stocked Laminate | 2248                          | 2500                     | 2291                     | 2487                 |
| <b>30 ROUND x 24H</b><br>DIA: 30 H: 24 |  | <b>DV1-30D24-( )</b> | Maple Veneer     | 3215                          | 3467                     | 3258                     | 3454                 |
|  |  | <b>DL1-30D24-( )</b> | Stocked Laminate | 2314                          | 2566                     | 2357                     | 2553                 |

Add SOLID SURFACE ONLAY price to prices above

| 30 DIA SOLID SURFACE ONLAY UPCHARGE | A           | B         | C         | D         |
|-------------------------------------|-------------|-----------|-----------|-----------|
| Stocked                             | 1765 LIST   | 1765 LIST | 1972 LIST | 2181 LIST |
| Non-stocked (per color, per order)  | ADD 410 NET | 450 NET   | 490 NET   | 520 NET   |

**NOTE: 1/2" Solid Surface Onlay will increase overall height by 1/2".**

|                                     | MODEL         | DESCRIPTION                   | PRICE        |
|-------------------------------------|---------------|-------------------------------|--------------|
| <b>30 DIA BOTTOM EDGE PROTECTOR</b> | <b>EPOD30</b> | For use with 30" Round Tables | ADD 248 LIST |

|  |  | MODEL                | TOP              | PLINTH BASE<br>VP, LP, BP, NB | BLACK METAL PLINTH<br>MP | WOOD/ALUM LEGS<br>CW, BA | METAL LEGS<br>BC, BM |
|--|--|----------------------|------------------|-------------------------------|--------------------------|--------------------------|----------------------|
| <b>36 ROUND x 18H</b><br>DIA: 36 H: 18 |  | <b>DV1-36D18-( )</b> | Maple Veneer     | 3266                          | 3540                     | 3258                     | 3454                 |
|  |  | <b>DL1-36D18-( )</b> | Stocked Laminate | 2459                          | 2733                     | 2451                     | 2647                 |
| <b>36 ROUND x 21H</b><br>DIA: 36 H: 21 |  | <b>DV1-36D21-( )</b> | Maple Veneer     | 3527                          | 3801                     | 3519                     | 3715                 |
|  |  | <b>DL1-36D21-( )</b> | Stocked Laminate | 2644                          | 2918                     | 2636                     | 2832                 |
| <b>36 ROUND x 24H</b><br>DIA: 36 H: 24 |  | <b>DV1-36D24-( )</b> | Maple Veneer     | 3730                          | 4004                     | 3722                     | 3918                 |
|  |  | <b>DL1-36D24-( )</b> | Stocked Laminate | 2793                          | 3067                     | 2785                     | 2981                 |

Add SOLID SURFACE ONLAY price to prices above

| 36 DIA SOLID SURFACE ONLAY UPCHARGE | A           | B         | C         | D         |
|-------------------------------------|-------------|-----------|-----------|-----------|
| Stocked                             | 2542 LIST   | 2542 LIST | 2840 LIST | 3140 LIST |
| Non-stocked (per color, per order)  | ADD 410 NET | 450 NET   | 490 NET   | 520 NET   |

**NOTE: 1/2" Solid Surface Onlay will increase overall height by 1/2".**

|                                     | MODEL         | DESCRIPTION                   | PRICE        |
|-------------------------------------|---------------|-------------------------------|--------------|
| <b>36 DIA BOTTOM EDGE PROTECTOR</b> | <b>EPOD36</b> | For use with 36" Round Tables | ADD 355 LIST |

|  |  |             |
|--|--|-------------|
| <b>NON-STOCKED / CUSTOM FINISH UPCHARGES</b> | Non-Stocked Laminate (per color, per order)  | ADD 50 NET  |
|  | Custom Wood Finish (CWF) (one-time upcharge) | ADD 300 NET |

### KEY FOR SPECIFYING DRUM TABLES:

Replace ( ) in the product code with the following to specify legs/base. NOTE: Plinth Base Shown.

|                 |   |
|-----------------|---|
| <b>VP or LP</b> | 3"H Plinth Base with matching Veneer (VP) or Laminate (LP)      |
| <b>BP</b>       | 3"H Plinth Base with Black Laminate                             |
| <b>MP</b>       | 3"H Black Metal Plinth Base                                     |
| <b>CW</b>       | 5"H Hard Maple Legs (to match Coffee House Wood Legs)           |
| <b>BC</b>       | 5"H Brushed Chrome Metal Legs                                   |
| <b>BM</b>       | 5"H Powder Coated Metal Legs (specify Powder Coat)              |
| <b>BA</b>       | 5"H Brushed Aluminum Legs (to match Coffee House Aluminum Legs) |
| <b>NB</b>       | No Base   |



**SELF EDGE  
DETAIL  
WITH SOLID  
SURFACE TOP**



**ELECTRICAL / POWER PORT**

Power Ports are available on Drum tables; however, due to the many sizes and options available, a drawing will be required for each table (when sizes or placement vary) showing the Power Port location desired. Power Ports must be placed on a flat surface.

Tables will be subject to a custom engineering fee of \$300 NET for each different sized table or tables requiring different Power Port locations. Contact Integra Customer Service for Pricing.

**PRODUCT OPTIONS**

**PERMA-COAT WOOD LEG PROTECTOR** \$38 List / Leg



# TABLE COLLECTIONS | CUBES

COMPONENT-BASED CONSTRUCTION

## CUBE WITH 3/4" RADIUSED SOLID WOOD EDGE

HARD MAPLE OR LAMINATE

|   | MODEL                    | TOP              | PLINTH BASE<br>VP, LP, BP, NB | BLACK METAL PLINTH<br>MP | WOOD/ALUM LEGS<br>CW, BA | METAL LEGS<br>BC, BM |
|---|--------------------------|------------------|-------------------------------|--------------------------|--------------------------|----------------------|
| <b>18 SQUARE x 18H</b><br>W: 18 D: 18 H: 18 | <b>CV2-1818SQ-18-(_)</b> | Maple Veneer     | 2779                          | 2945                     | 2875                     | 3071                 |
|   | <b>CL2-1818SQ-18-(_)</b> | Stocked Laminate | 2714                          | 2880                     | 2810                     | 3006                 |
| <b>18 SQUARE x 21H</b><br>W: 18 D: 18 H: 21 | <b>CV2-1818SQ-21-(_)</b> | Maple Veneer     | 2923                          | 3089                     | 3019                     | 3215                 |
|   | <b>CL2-1818SQ-21-(_)</b> | Stocked Laminate | 2779                          | 2945                     | 2875                     | 3071                 |
| <b>18 SQUARE x 24H</b><br>W: 18 D: 18 H: 24 | <b>CV2-1818SQ-24-(_)</b> | Maple Veneer     | 3053                          | 3219                     | 3149                     | 3345                 |
|   | <b>CL2-1818SQ-24-(_)</b> | Stocked Laminate | 2824                          | 2990                     | 2920                     | 3116                 |

Add SOLID SURFACE ONLAY price to prices above

| 18 x 18 SOLID SURFACE ONLAY UPCHARGE | A           | B        | C        | D        |
|--------------------------------------|-------------|----------|----------|----------|
| Stocked                              | 636 LIST    | 636 LIST | 712 LIST | 785 LIST |
| Non-stocked (per color, per order)   | ADD 410 NET | 450 NET  | 490 NET  | 520 NET  |

**NOTE: 1/2" Solid Surface Onlay will increase overall height by 1/2".**

|                                      | MODEL         | DESCRIPTION                    | PRICE       |
|--------------------------------------|---------------|--------------------------------|-------------|
| <b>18 x 18 BOTTOM EDGE PROTECTOR</b> | <b>EPOC18</b> | For use with 18" Square Tables | ADD 94 LIST |

|   | MODEL                 | TOP              | PLINTH BASE<br>VP, LP, BP, NB | BLACK METAL PLINTH<br>MP | WOOD/ALUM LEGS<br>CW, BA | METAL LEGS<br>BC, BM |
|---|-----------------------|------------------|-------------------------------|--------------------------|--------------------------|----------------------|
| <b>24 SQUARE x 18H</b><br>W: 24 D: 24 H: 18 | <b>CV2-242418-(_)</b> | Maple Veneer     | 3305                          | 3506                     | 3373                     | 3569                 |
|   | <b>CL2-242418-(_)</b> | Stocked Laminate | 3105                          | 3306                     | 3173                     | 3369                 |
| <b>24 SQUARE x 21H</b><br>W: 24 D: 24 H: 21 | <b>CV2-242421-(_)</b> | Maple Veneer     | 3487                          | 3688                     | 3555                     | 3751                 |
|   | <b>CL2-242421-(_)</b> | Stocked Laminate | 3213                          | 3414                     | 3281                     | 3477                 |
| <b>24 SQUARE x 24H</b><br>W: 24 D: 24 H: 24 | <b>CV2-242424-(_)</b> | Maple Veneer     | 3688                          | 3889                     | 3756                     | 3952                 |
|   | <b>CL2-242424-(_)</b> | Stocked Laminate | 3282                          | 3483                     | 3350                     | 3546                 |

Add SOLID SURFACE ONLAY price to prices above

| 24 x 24 SOLID SURFACE ONLAY UPCHARGE | A           | B         | C         | D         |
|--------------------------------------|-------------|-----------|-----------|-----------|
| Stocked                              | 1129 LIST   | 1129 LIST | 1263 LIST | 1395 LIST |
| Non-stocked (per color, per order)   | ADD 410 NET | 450 NET   | 490 NET   | 520 NET   |

**NOTE: 1/2" Solid Surface Onlay will increase overall height by 1/2".**

|                                      | MODEL         | DESCRIPTION                    | PRICE        |
|--------------------------------------|---------------|--------------------------------|--------------|
| <b>24 x 24 BOTTOM EDGE PROTECTOR</b> | <b>EPOC24</b> | For use with 24" Square Tables | ADD 219 LIST |

|  |  |             |
|--|--|-------------|
| <b>NON-STOCKED / CUSTOM FINISH UPCHARGES</b> | Non-Stocked Laminate (per color, per order)  | ADD 50 NET  |
|  | Custom Wood Finish (CWF) (one-time upcharge) | ADD 300 NET |

### KEY FOR SPECIFYING CUBE TABLES:

Replace ( ) in the product code with the following to specify legs/base. NOTE: Plinth Base Shown.

|                 |   |
|-----------------|---|
| <b>VP or LP</b> | 3"H Plinth Base with matching Veneer (VP) or Laminate (LP)      |
| <b>BP</b>       | 3"H Plinth Base with Black Laminate                             |
| <b>MP</b>       | 3"H Black Metal Plinth Base                                     |
| <b>CW</b>       | 5"H Hard Maple Legs (to match Coffee House Wood Legs)           |
| <b>BC</b>       | 5"H Brushed Chrome Metal Legs                                   |
| <b>BM</b>       | 5"H Powder Coated Metal Legs (specify Powder Coat)              |
| <b>BA</b>       | 5"H Brushed Aluminum Legs (to match Coffee House Aluminum Legs) |
| <b>NB</b>       | No Base   |



**SOLID WOOD EDGE DETAIL WITH SOLID SURFACE TOP**  
Will have 3/4" exposed edge detail as shown.



## CUBE WITH 3/4" RADIUS ED SOLID WOOD EDGE

|   | MODEL                            | TOP              | PLINTH BASE<br>VP, LP, BP, NB | BLACK METAL PLINTH<br>MP | WOOD/ALUM LEGS<br>CW, BA | METAL LEGS<br>BC, BM |
|---|----------------------------------|------------------|-------------------------------|--------------------------|--------------------------|----------------------|
| <b>30 SQUARE x 18H</b><br>W: 30 D: 30 H: 18 | <b>CV2-303018</b> -( <u>  </u> ) | Maple Veneer     | 4154                          | 4470                     | 4197                     | 4393                 |
|   | <b>CL2-303018</b> -( <u>  </u> ) | Stocked Laminate | 3536                          | 3852                     | 3579                     | 3775                 |
| <b>30 SQUARE x 21H</b><br>W: 30 D: 30 H: 21 | <b>CV2-303021</b> -( <u>  </u> ) | Maple Veneer     | 4282                          | 4598                     | 4325                     | 4521                 |
|   | <b>CL2-303021</b> -( <u>  </u> ) | Stocked Laminate | 3708                          | 4024                     | 3751                     | 3947                 |
| <b>30 SQUARE x 24H</b><br>W: 30 D: 30 H: 24 | <b>CV2-303024</b> -( <u>  </u> ) | Maple Veneer     | 4397                          | 4713                     | 4440                     | 4636                 |
|   | <b>CL2-303024</b> -( <u>  </u> ) | Stocked Laminate | 3798                          | 4114                     | 3841                     | 4037                 |

Add SOLID SURFACE ONLAY price to prices above

| 30 x 30 SOLID SURFACE ONLAY UPCHARGE | A           | B         | C         | D         |
|--------------------------------------|-------------|-----------|-----------|-----------|
| Stocked                              | 1765 LIST   | 1765 LIST | 1972 LIST | 2181 LIST |
| Non-stocked (per color, per order)   | ADD 410 NET | 450 NET   | 490 NET   | 520 NET   |

**NOTE: 1/2" Solid Surface Onlay will increase overall height by 1/2".**

|                                      | MODEL         | DESCRIPTION                    | PRICE        |
|--------------------------------------|---------------|--------------------------------|--------------|
| <b>30 x 30 BOTTOM EDGE PROTECTOR</b> | <b>EPOC30</b> | For use with 30" Square Tables | ADD 248 LIST |

|   | MODEL                            | TOP              | PLINTH BASE<br>VP, LP, BP, NB | BLACK METAL PLINTH<br>MP | WOOD/ALUM LEGS<br>CW, BA | METAL LEGS<br>BC, BM |
|---|----------------------------------|------------------|-------------------------------|--------------------------|--------------------------|----------------------|
| <b>36 SQUARE x 18H</b><br>W: 36 D: 36 H: 18 | <b>CV2-363618</b> -( <u>  </u> ) | Maple Veneer     | 4815                          | 5172                     | 4807                     | 5003                 |
|   | <b>CL2-363618</b> -( <u>  </u> ) | Stocked Laminate | 3992                          | 4349                     | 3984                     | 4180                 |
| <b>36 SQUARE x 21H</b><br>W: 36 D: 36 H: 21 | <b>CV2-363621</b> -( <u>  </u> ) | Maple Veneer     | 4908                          | 5265                     | 4900                     | 5096                 |
|   | <b>CL2-363621</b> -( <u>  </u> ) | Stocked Laminate | 4187                          | 4544                     | 4179                     | 4375                 |
| <b>36 SQUARE x 24H</b><br>W: 36 D: 36 H: 24 | <b>CV2-363624</b> -( <u>  </u> ) | Maple Veneer     | 5084                          | 5441                     | 5076                     | 5272                 |
|   | <b>CL2-363624</b> -( <u>  </u> ) | Stocked Laminate | 4364                          | 4721                     | 4356                     | 4552                 |

Add SOLID SURFACE ONLAY price to prices above

| 36 x 36 SOLID SURFACE ONLAY UPCHARGE | A           | B         | C         | D         |
|--------------------------------------|-------------|-----------|-----------|-----------|
| Stocked                              | 2542 LIST   | 2542 LIST | 2840 LIST | 3140 LIST |
| Non-stocked (per color, per order)   | ADD 410 NET | 450 NET   | 490 NET   | 520 NET   |

**NOTE: 1/2" Solid Surface Onlay will increase overall height by 1/2".**

|                                      | MODEL         | DESCRIPTION                    | PRICE        |
|--------------------------------------|---------------|--------------------------------|--------------|
| <b>36 x 36 BOTTOM EDGE PROTECTOR</b> | <b>EPOC36</b> | For use with 36" Square Tables | ADD 355 LIST |

### NON-STOCKED / CUSTOM FINISH UPCHARGES

|  |     |         |
|--|-----|---------|
| Non-Stocked Laminate (per color, per order)  | ADD | 50 NET  |
| Custom Wood Finish (CWF) (one-time upcharge) | ADD | 300 NET |

### KEY FOR SPECIFYING CUBE TABLES:

Replace (  ) in the product code with the following to specify legs/base. NOTE: Plinth Base Shown.

|                 |   |
|-----------------|---|
| <b>VP or LP</b> | 3"H Plinth Base with matching Veneer (VP) or Laminate (LP)      |
| <b>BP</b>       | 3"H Plinth Base with Black Laminate                             |
| <b>MP</b>       | 3"H Black Metal Plinth Base                                     |
| <b>CW</b>       | 5"H Hard Maple Legs (to match Coffee House Wood Legs)           |
| <b>BC</b>       | 5"H Brushed Chrome Metal Legs                                   |
| <b>BM</b>       | 5"H Powder Coated Metal Legs (specify Powder Coat)              |
| <b>BA</b>       | 5"H Brushed Aluminum Legs (to match Coffee House Aluminum Legs) |
| <b>NB</b>       | No Base   |



**SOLID WOOD EDGE DETAIL WITH SOLID SURFACE TOP**  
Will have 3/4" exposed edge detail as shown.



**ELECTRICAL / POWER PORT**

Power Ports are available on Cube tables; however, due to the many sizes and options available, a drawing will be required for each table (when sizes or placement vary) showing the Power Port location desired. Power Ports must be placed on a flat surface.

Tables will be subject to a custom engineering fee of \$300 NET for each different sized table or tables requiring different Power Port locations. Contact Integra Customer Service for Pricing.

**PRODUCT OPTIONS**

**PERMA-COAT WOOD LEG PROTECTOR** \$38 List / Leg





# TABLE COLLECTIONS | DRUMS

COMPONENT-BASED CONSTRUCTION

## DRUM WITH 3/4" RADIUS SOLID WOOD EDGE

HARD MAPLE OR LAMINATE

|  |  | MODEL                | TOP              | PLINTH BASE<br>VP, LP, BP, NB | BLACK METAL PLINTH<br>MP | WOOD/ALUM LEGS<br>CW, BA | METAL LEGS<br>BC, BM |
|--|--|----------------------|------------------|-------------------------------|--------------------------|--------------------------|----------------------|
| <b>18 ROUND x 18H</b><br>DIA: 18 H: 18 |  | <b>DV2-18D18-( )</b> | Maple Veneer     | 2636                          | 2767                     | 2732                     | 2928                 |
|  |  | <b>DL2-18D18-( )</b> | Stocked Laminate | 2636                          | 2767                     | 2732                     | 2928                 |
| <b>18 ROUND x 21H</b><br>DIA: 18 H: 21 |  | <b>DV2-18D21-( )</b> | Maple Veneer     | 2756                          | 2887                     | 2852                     | 3048                 |
|  |  | <b>DL2-18D21-( )</b> | Stocked Laminate | 2756                          | 2887                     | 2852                     | 3048                 |
| <b>18 ROUND x 24H</b><br>DIA: 18 H: 24 |  | <b>DV2-18D24-( )</b> | Maple Veneer     | 2882                          | 3013                     | 2978                     | 3174                 |
|  |  | <b>DL2-18D24-( )</b> | Stocked Laminate | 2824                          | 2955                     | 2920                     | 3116                 |

Add SOLID SURFACE ONLAY price to prices above

| 18 DIA SOLID SURFACE ONLAY UPCHARGE | A           | B        | C        | D        |
|-------------------------------------|-------------|----------|----------|----------|
| Stocked                             | 636 LIST    | 636 LIST | 712 LIST | 785 LIST |
| Non-stocked (per color, per order)  | ADD 410 NET | 450 NET  | 490 NET  | 520 NET  |

**NOTE: 1/2" Solid Surface Onlay will increase overall height by 1/2".**

|                                     | MODEL         | DESCRIPTION                   | PRICE       |
|-------------------------------------|---------------|-------------------------------|-------------|
| <b>18 DIA BOTTOM EDGE PROTECTOR</b> | <b>EPOD18</b> | For use with 18" Round Tables | ADD 94 LIST |

|  |  | MODEL                | TOP              | PLINTH BASE<br>VP, LP, BP, NB | BLACK METAL PLINTH<br>MP | WOOD/ALUM LEGS<br>CW, BA | METAL LEGS<br>BC, BM |
|--|--|----------------------|------------------|-------------------------------|--------------------------|--------------------------|----------------------|
| <b>24 ROUND x 18H</b><br>DIA: 24 H: 18 |  | <b>DV2-24D18-( )</b> | Maple Veneer     | 3096                          | 3264                     | 3164                     | 3360                 |
|  |  | <b>DL2-24D18-( )</b> | Stocked Laminate | 3096                          | 3264                     | 3164                     | 3360                 |
| <b>24 ROUND x 21H</b><br>DIA: 24 H: 21 |  | <b>DV2-24D21-( )</b> | Maple Veneer     | 3213                          | 3381                     | 3281                     | 3477                 |
|  |  | <b>DL2-24D21-( )</b> | Stocked Laminate | 3213                          | 3381                     | 3281                     | 3477                 |
| <b>24 ROUND x 24H</b><br>DIA: 24 H: 24 |  | <b>DV2-24D24-( )</b> | Maple Veneer     | 3339                          | 3507                     | 3407                     | 3603                 |
|  |  | <b>DL2-24D24-( )</b> | Stocked Laminate | 3282                          | 3450                     | 3350                     | 3546                 |

Add SOLID SURFACE ONLAY price to prices above

| 24 DIA SOLID SURFACE ONLAY UPCHARGE | A           | B         | C         | D         |
|-------------------------------------|-------------|-----------|-----------|-----------|
| Stocked                             | 1129 LIST   | 1129 LIST | 1263 LIST | 1395 LIST |
| Non-stocked (per color, per order)  | ADD 410 NET | 450 NET   | 490 NET   | 520 NET   |

**NOTE: 1/2" Solid Surface Onlay will increase overall height by 1/2".**

|                                     | MODEL         | DESCRIPTION                   | PRICE        |
|-------------------------------------|---------------|-------------------------------|--------------|
| <b>24 DIA BOTTOM EDGE PROTECTOR</b> | <b>EPOD24</b> | For use with 24" Round Tables | ADD 140 LIST |

### NON-STOCKED / CUSTOM FINISH UPCHARGES

|  |     |         |
|--|-----|---------|
| Non-Stocked Laminate (per color, per order)  | ADD | 50 NET  |
| Custom Wood Finish (CWF) (one-time upcharge) | ADD | 300 NET |

### KEY FOR SPECIFYING DRUM TABLES:

Replace ( ) in the product code with the following to specify legs/base. NOTE: Plinth Base Shown.

|                 |   |
|-----------------|---|
| <b>VP or LP</b> | 3"H Plinth Base with matching Veneer (VP) or Laminate (LP)      |
| <b>BP</b>       | 3"H Plinth Base with Black Laminate                             |
| <b>MP</b>       | 3"H Black Metal Plinth Base                                     |
| <b>CW</b>       | 5"H Hard Maple Legs (to match Coffee House Wood Legs)           |
| <b>BC</b>       | 5"H Brushed Chrome Metal Legs                                   |
| <b>BM</b>       | 5"H Powder Coated Metal Legs (specify Powder Coat)              |
| <b>BA</b>       | 5"H Brushed Aluminum Legs (to match Coffee House Aluminum Legs) |
| <b>NB</b>       | No Base   |



**SOLID WOOD EDGE DETAIL WITH SOLID SURFACE TOP**  
Will have 3/4" exposed edge detail as shown.



## DRUM WITH 3/4" RADIUS SOLID WOOD EDGE

|  |  | MODEL                | TOP              | PLINTH BASE<br>VP, LP, BP, NB | BLACK METAL PLINTH<br>MP | WOOD/ALUM LEGS<br>CW, BA | METAL LEGS<br>BC, BM |
|--|--|----------------------|------------------|-------------------------------|--------------------------|--------------------------|----------------------|
| <b>30 ROUND x 18H</b><br>DIA: 30 H: 18 |  | <b>DV2-30D18-(_)</b> | Maple Veneer     | 3815                          | 4067                     | 3858                     | 4054                 |
|  |  | <b>DL2-30D18-(_)</b> | Stocked Laminate | 3536                          | 3788                     | 3579                     | 3775                 |
| <b>30 ROUND x 21H</b><br>DIA: 30 H: 21 |  | <b>DV2-30D21-(_)</b> | Maple Veneer     | 4018                          | 4270                     | 4061                     | 4257                 |
|  |  | <b>DL2-30D21-(_)</b> | Stocked Laminate | 3708                          | 3960                     | 3751                     | 3947                 |
| <b>30 ROUND x 24H</b><br>DIA: 30 H: 24 |  | <b>DV2-30D24-(_)</b> | Maple Veneer     | 4145                          | 4397                     | 4188                     | 4384                 |
|  |  | <b>DL2-30D24-(_)</b> | Stocked Laminate | 3798                          | 4050                     | 3841                     | 4037                 |

Add SOLID SURFACE ONLAY price to prices above

| 30 DIA SOLID SURFACE ONLAY UPCHARGE | A           | B         | C         | D         |
|-------------------------------------|-------------|-----------|-----------|-----------|
| Stocked                             | 1765 LIST   | 1765 LIST | 1972 LIST | 2181 LIST |
| Non-stocked (per color, per order)  | ADD 410 NET | 450 NET   | 490 NET   | 520 NET   |

**NOTE: 1/2" Solid Surface Onlay will increase overall height by 1/2".**

|                                     | MODEL         | DESCRIPTION                   | PRICE        |
|-------------------------------------|---------------|-------------------------------|--------------|
| <b>30 DIA BOTTOM EDGE PROTECTOR</b> | <b>EPOD30</b> | For use with 30" Round Tables | ADD 248 LIST |

|  |  | MODEL                | TOP              | PLINTH BASE<br>VP, LP, BP, NB | BLACK METAL PLINTH<br>MP | WOOD/ALUM LEGS<br>CW, BA | METAL LEGS<br>BC, BM |
|--|--|----------------------|------------------|-------------------------------|--------------------------|--------------------------|----------------------|
| <b>36 ROUND x 18H</b><br>DIA: 36 H: 18 |  | <b>DV2-36D18-(_)</b> | Maple Veneer     | 4315                          | 4589                     | 4307                     | 4503                 |
|  |  | <b>DL2-36D18-(_)</b> | Stocked Laminate | 3992                          | 4266                     | 3984                     | 4180                 |
| <b>36 ROUND x 21H</b><br>DIA: 36 H: 21 |  | <b>DV2-36D21-(_)</b> | Maple Veneer     | 4577                          | 4851                     | 4569                     | 4765                 |
|  |  | <b>DL2-36D21-(_)</b> | Stocked Laminate | 4187                          | 4461                     | 4179                     | 4375                 |
| <b>36 ROUND x 24H</b><br>DIA: 36 H: 24 |  | <b>DV2-36D24-(_)</b> | Maple Veneer     | 4679                          | 4953                     | 4671                     | 4867                 |
|  |  | <b>DL2-36D24-(_)</b> | Stocked Laminate | 4364                          | 4638                     | 4356                     | 4552                 |

Add SOLID SURFACE ONLAY price to prices above

| 36 DIA SOLID SURFACE ONLAY UPCHARGE | A           | B         | C         | D         |
|-------------------------------------|-------------|-----------|-----------|-----------|
| Stocked                             | 2542 LIST   | 2542 LIST | 2840 LIST | 3140 LIST |
| Non-stocked (per color, per order)  | ADD 410 NET | 450 NET   | 490 NET   | 520 NET   |

**NOTE: 1/2" Solid Surface Onlay will increase overall height by 1/2".**

|                                     | MODEL         | DESCRIPTION                   | PRICE        |
|-------------------------------------|---------------|-------------------------------|--------------|
| <b>36 DIA BOTTOM EDGE PROTECTOR</b> | <b>EPOD36</b> | For use with 36" Round Tables | ADD 355 LIST |

|  |  |             |
|--|--|-------------|
| <b>NON-STOCKED / CUSTOM FINISH UPCHARGES</b> | Non-Stocked Laminate (per color, per order)  | ADD 50 NET  |
|  | Custom Wood Finish (CWF) (one-time upcharge) | ADD 300 NET |

### KEY FOR SPECIFYING DRUM TABLES:

Replace ( ) in the product code with the following to specify legs/base. NOTE: Plinth Base Shown.

|                 |   |
|-----------------|---|
| <b>VP or LP</b> | 3"H Plinth Base with matching Veneer (VP) or Laminate (LP)      |
| <b>BP</b>       | 3"H Plinth Base with Black Laminate                             |
| <b>MP</b>       | 3"H Black Metal Plinth Base                                     |
| <b>CW</b>       | 5"H Hard Maple Legs (to match Coffee House Wood Legs)           |
| <b>BC</b>       | 5"H Brushed Chrome Metal Legs                                   |
| <b>BM</b>       | 5"H Powder Coated Metal Legs (specify Powder Coat)              |
| <b>BA</b>       | 5"H Brushed Aluminum Legs (to match Coffee House Aluminum Legs) |
| <b>NB</b>       | No Base   |



**SOLID WOOD EDGE DETAIL WITH SOLID SURFACE TOP**  
Will have 3/4" exposed edge detail as shown.



**ELECTRICAL / POWER PORT**

Power Ports are available on Drum tables; however, due to the many sizes and options available, a drawing will be required for each table (when sizes or placement vary) showing the Power Port location desired. Power Ports must be placed on a flat surface.

Tables will be subject to a custom engineering fee of \$300 NET for each different sized table or tables requiring different Power Port locations. Contact Integra Customer Service for Pricing.

**PRODUCT OPTIONS**

**PERMA-COAT WOOD LEG PROTECTOR** \$38 List / Leg



**SOLID SURFACE TOP**

W: 15 D: 17 H: 27.25



| MODEL    | GRADE                              | A           | B         | C         | D         |
|----------|------------------------------------|-------------|-----------|-----------|-----------|
| KIXSY-SS | Stocked                            | 1068 LIST   | 1099 LIST | 1148 LIST | 1223 LIST |
|          | Non-stocked (per color, per order) | ADD 410 NET | 450 NET   | 490 NET   | 520 NET   |

**NOTE: Must specify powder coat finish for base.**

**LAMINATE/PLYWOOD EDGE TOP**

W: 15 D: 17 H: 27.25

| MODEL    | GRADE   | PRICE      |
|----------|---|------------|
| KIXSY-LM | Stocked (Laminate tablets have a plywood edge. Specify finish.) | 989 LIST   |
|          | Non-stocked (per color, per order)                              | ADD 50 NET |

**NOTE: Must specify powder coat finish for base.**

**VENEER/PLYWOOD EDGE TOP**

W: 15 D: 17 H: 27.25

| MODEL    | GRADE                                     | PRICE       |
|----------|---|-------------|
| KIXSY-VT | Standard Wood Finish                      | 989 LIST    |
|          | Custom Finish (one time charge per color) | ADD 300 NET |

**NOTE: Must specify powder coat finish for base.**





# INTEGRA | STOCKED FINISHES

## SOLID SURFACE | STOCKED OPTIONS

INTEGRASEATING.COM/FINISHES

### GRADE

|          |                   |   |
|----------|-------------------|---|
| <b>A</b> | <b>LG HI-MACS</b> | Arctic White, Cream, Almond Pearl             |
| <b>B</b> | <b>LG HI-MACS</b> | Allspice Quartz, Venetian Sand, Desert Sand   |
| <b>C</b> | <b>LG HI-MACS</b> | Glitz, Gray, Haze                             |
| <b>D</b> | <b>CORIAN</b>     | Deep Titanium, Deep Sable, Weathered Concrete |

## METAL FINISH | STANDARD OPTIONS

|                    |         |           |        |           |                  |           |
|--------------------|---------|-----------|--------|-----------|------------------|-----------|
| <b>POWDER COAT</b> | Glacier | <b>CX</b> | Bronze | <b>ZX</b> | BRUSHED CHROME   | <b>BC</b> |
|                    | Chalk   | <b>HX</b> | Bark   | <b>KX</b> | BRUSHED ALUMINUM | <b>BA</b> |
|                    | Cement  | <b>MX</b> | Slate  | <b>SX</b> |                  |           |
|                    | Silver  | <b>VX</b> | Onyx   | <b>BX</b> |                  |           |
|                    | Fossil  | <b>FX</b> |        |           |                  |           |

**NOTE: See each series for available standards.**

## WOOD FINISH | STANDARD OPTIONS

HARD MAPLE

|                        |          |             |                        |          |         |
|------------------------|----------|-------------|------------------------|----------|---------|
| <b>INSPIRED COLORS</b> | Sugar    | Pewter Mist | <b>ORIGINAL COLORS</b> | Vanilla  | Saffron |
|                        | Sea Salt | Poppy Seed  |                        | Ginger   | Chili   |
|                        | Almond   | Hazelnut    |                        | Cinnamon | Clove   |
|                        | Jasmine  | Mocha       |                        | Nutmeg   | Pepper  |

**NOTE: Custom Wood Finishes are available at a one-time upcharge of \$300 Net per color. Contact your customer service representative for more details.**

## STOCKED LAMINATE OPTIONS FOR WOOD FINISHES

| INSPIRED WOOD FINISH | HPL MANUFACTURER | NAME/PATTERN          | ID#      | ORIGINAL WOOD FINISH | HPL MANUFACTURER | NAME/PATTERN    | ID#       |
|----------------------|------------------|-----------------------|----------|----------------------|------------------|-----------------|-----------|
| Sugar                | Wilsonart        | Phantom Pearl         | 8211K-28 | Vanilla              | Pionite          | Hardrock Maple  | WM791-S   |
| Sea Salt (opt. 1)    | Wilsonart        | Asian Sand            | 7952K-18 | Ginger               | Pionite          | Millwork Cherry | WC431-PV  |
| Sea Salt (opt. 2)    | Wilsonart        | Wallaby               | D439-60  | Cinnamon             | Nevamar          | Blossom Cherry  | WC5581N   |
| Almond               | Wilsonart        | Raw Chestnut          | 7975K-12 | Nutmeg               | Wilsonart        | Cherrywood      | 11062K-07 |
| Jasmine              | Nevamar          | Beige Renaissance     | WM8258-T | Saffron              | Wilsonart        | Judicial Walnut | 11065K-07 |
| Pewter Mist          | Nevamar          | Luminary Teak         | WT0005T  | Chili                | Wilsonart        | Empire Mahogany | 7122K-07  |
| Poppy Seed (opt. 1)  | Formica          | Silver Riftwood       | 6413-NG  | Clove                | Wilsonart        | Cafelle         | 7933K-07  |
| Poppy Seed (opt. 2)  | Pionite          | Absolute Acajou       | WY160-SD | Clove (alt)          | Wilsonart        | Cocobala        | 7942K-07  |
| Poppy Seed (opt. 3)  | Wilsonart        | Phantom Cocoa         | 8213K-28 | Pepper               | Wilsonart        | Black           | 1595K-07  |
| Poppy Seed (opt. 4)  | Wilsonart        | Skyline Walnut        | 7964K-12 |                      |                  |                 |           |
| Hazelnut (opt. 1)    | Wilsonart        | Studio Teak           | 7960K-18 |                      |                  |                 |           |
| Hazelnut (opt. 2)    | Pionite          | Pralines & Cream      | WW160-SD |                      |                  |                 |           |
| Mocha (opt. 1)       | Wilsonart        | Hampton Walnut        | 7959K-78 |                      |                  |                 |           |
| Mocha (opt. 2)       | Formica          | Cocoa Maple           | 7739-58  |                      |                  |                 |           |
| Mocha (opt. 3)       | Pionite          | Gunstock Savoy Walnut | WW971-SD |                      |                  |                 |           |

**NOTE: Non-Stocked Laminate selections incur a \$50 Net charge per color, per order.**



## ORDERING & SPECIFICATIONS

### HOW TO USE THIS PRICE LIST

Each series or collection has the available options within that series. Available options may include: legs/bases, arm caps, seats, tablets, power, and other product options. Please see each series for the available options, details, and pricing.

Integra's PDF price list has links from the Table of Contents to each section for easier movement through the document. Also, at the top of each page is an icon that will take you back to the Table of Contents page.

And of course, our exceptional Customer Service Team is happy to help you with quotes, product questions and anything else you need to work with Integra products!

### GENERAL ORDERING INFORMATION

Direct all orders to: **INTEGRA, INC.**  
PO BOX M  
807 Wisconsin Street  
Walworth, WI 53184  
(800) 235-0234 (262) 275-2161 (262) 275-3614 FAX  
orderentry@integraseating.com

When placing an order, please be sure to include ALL of the following:

- Your Company Name, Address, Telephone, Fax and Email Address
- Contact Person for Order and Email Address
- Purchase Order Number, Bill To Address, Ship to Address, Order Date
- Integra Quote Number, if Integra provided a Quote
- Quantity
- Product Code/Number
- Product Description
- Selected Options
- Fabric: Pattern and Color
- Wood Species
- Wood Finish
- Line Drawings for System Orders
- Requested Ship Date
- Any Special Instructions

#### ORDERS & ORDER CONFIRMATION:

Orders may be received via fax, mail or emailed to customerservice@integraseating.com. Acknowledgments will be emailed. Changes in the ship to address after order entry will incur additional charges.

#### CHANGE ORDERS AND CANCELLATIONS:

Written changes on orders or cancellations of orders will only be accepted within 48 hours after receipt of order.

#### PRICES:

Published prices are List F.O.B. destination on shipments over \$7,500 List and within the Contiguous U.S. Shipments under \$7,500 List will incur a \$300 NET freight charge. Integra prefers to ship furniture set-up at the factory and blanket-wrapped. In certain instances, furniture will be packaged in cartons and shipped; cartoning charges may apply.

Prices do not include:

- storage or insurance charges
- sales or other taxes
- multiple deliveries, uncartoning, assembly, or installation

#### TERMS OF PAYMENT:

Orders require prepayment upon placement of original order, balance required prior to shipment. Terms for accredited customers are NET 30. Integra may request advance payment at any time. A service charge for any special handling may be assessed. A service charge of 1.5% per month will be assessed on unpaid balance of all past due accounts.

#### RETURNS:

No returns of furniture will be accepted without our written consent and shipping instructions. Special order items are not subject to return.

### DESIGN AND SPECIFICATIONS

Integra reserves the right to alter product design for purposes at our discretion including: construction and material improvements, pricing or dimension corrections, and other purposes without notification. All dimensions shown are approximate. If critical specifications are required, please consult the factory.

#### GENERAL PRODUCT SPECIFICATIONS:

Integra's products listed in this contract price list include these features:

- High Resilience Foam in All Seat Units
- No-spring Dymetrol Suspension System in all seating that uses a suspension system
- 16 Gauge Steel Tubular Inner Structure and Assembly Patented to Integra
- All Integra chairs and seating units have a 1000 lbs dynamic load capacity and a 2000 lbs static load capacity.
- Product specifications for all product lines are available upon request

#### CUSTOM PRODUCT DESIGN & ENGINEERING:

Integra tries to accommodate custom request to best meet the needs of our customers. Please bring custom requests to our Project Management Team. They will work with our Engineering Team for review and approval. **If approved, most custom requests will incur a \$300 NET Custom Engineering Fee.** If the custom request involves a significant amount of custom design and engineering that charge may be increased. Our team will notify the requestor of any increase in charges.

#### LIFETIME WARRANTY:

Products manufactured by Integra after October, 1 2007 are warranted to be free of defects in material and workmanship under normal use for the lifetime of the product. Product must be properly assembled, maintained and in use by its original owner. Under the warranty, the obligation of Integra is limited to the repair or replacement of such furniture. Damage in transit or by negligence, abuse, abnormal usage, misuse, accidents or alterations nullifies the warranty.

As Buyer's sole remedy under this warranty, Integra, at its option, will repair or replace damaged parts at no charge to the original owner of record provided the replacement or return has previously been authorized by Integra under terms of this warranty. Normal aging and wear of fabrics, filling materials, and finishes are excepted from this warranty. Any labor charges incurred will be at the Buyer's expense. It is expressly agreed that this remedy of repair, replacement or credit, at Integra's option, is Buyer's exclusive remedy under this warranty. In no event shall Seller be liable for consequential damages.

All other express or implied warranties made by any sales representative, or agent, or other representative, including any warranty of merchantability or fitness for a particular use, are hereby excluded. A-Chairs carry a 10 year warranty. Electric Power Ports carry a one year warranty.

#### FABRICS:

In order to fit the wide range of our customer's needs, Integra currently has partnerships and graded-in programs with these textile companies:

|                      |                         |              |
|----------------------|-------------------------|--------------|
| Anzea                | www.anzea.com           | 877.862.6932 |
| Arc-Com              | www.arc-com.com         | 800.223.5466 |
| Architex             | www.architex-ljh.com    | 800.621.0827 |
| Camira               | www.camirafabrics.com   | 616.288.0655 |
| CF Stinson           | www.cfstinson.com       | 800.841.6279 |
| DesignTex            | www.designtex.com       | 800.221.1540 |
| EnviroLeather by LDI | www.lidiinteriors.com   | 866.332.0700 |
| Maharam              | www.maharam.com         | 800.645.3943 |
| Mayer                | www.mayerfabrics.com    | 800.428.4415 |
| Momentum             | www.memosamples.com     | 800.366.6839 |
| UltraFabrics         | www.ultrafabricsinc.com | 877.309.6648 |

For a listing of the current graded-in fabrics and grades, visit our website at [integraseating.com/fabrics](http://integraseating.com/fabrics).



## DESIGN AND SPECIFICATIONS (CONTINUED)

Integra offers a wide range of fabrics to our customers in our graded-in program. Integra does not stock fabric; all textiles are ordered from the distributor at the time we receive an order. Integra is not responsible for differences in color between material supplied and samples from which choices have been made, nor is Integra responsible for matching upholstery on existing product to any future orders. **Please note that Integra does not warranty fabrics and is not responsible for any replacement fabric, covers, or re-upholstery labor costs for failed fabrics whether graded-in or sent to us as a COM/COL. We can provide a quote for new covers at the time needed. Please contact the fabric companies for any warranty information on their own products.**

### COMBINATION FABRICS (Simple and Complex):

More than one fabric may be specified and applied to the same product. Integra does not upcharge for simple fabric combinations which consist of one fabric each on a component (i.e. seat, back, arm, or front panel). For simple combinations, the price is typically based upon the highest fabric grade of the chosen fabrics on the product. Complex fabric combinations consist of multiple fabrics on a single component, such as the front of the back in Fabric A and the back of the back is in Fabric B. Complex combinations will incur a 5% upcharge. Fabric combination forms are required at the time of order. Contact Customer Service for fabric combination forms or assistance.

### FABRIC APPLICATION:

Standard procedure is for Integra to match all fabrics that require matching such as plaids, prints, or stripes. If matching is not desired, this must be clearly noted on the purchase order. Integra will apply textiles to upholstered items in the manner which we deem to be the most appealing.

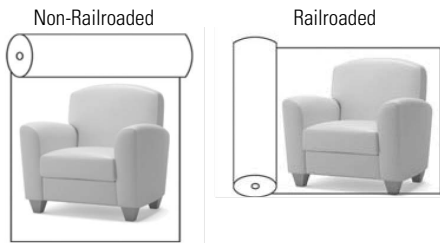

Standard procedure is for Integra to cut all fabrics non-railroaded unless otherwise clearly specified on the purchase order. See the diagrams above for a visual description of non-railroaded vs railroaded applications. To ensure correct cutting and application of the fabric, it is suggested that a clearly marked sample is sent with the purchase order when requesting a non-standard application of the fabric. Please note that when railroading fabric, it is possible that additional yardage may be required. Integra assumes no responsibility for the direction in which the textiles are applied unless it is clearly specified on the purchase order.

### FABRIC REPEATS:

**Fabric with larger repeats or smaller roll widths may require additional fabric than what is noted in the price list. Standard upholstery textile rolls are 54-inch wide. The yardage amounts noted are based upon 54-inch wide textiles without a pattern repeat.** For calculating additional yardage due to pattern repeat or a roll less than 54" wide, see chart below to match roll width with repeat amount. For the specific textile, with both the vertical & horizontal repeat measurements, use the larger of the two repeats then use the chart below for additional yardage requirements. Add the required additional % to the COM yardage amount noted in the current Integra Price List for total yardage needed per furniture item.

| UPH. TEXTILE ROLL WIDTH | SOLID NO REPEAT | REPEAT OF 2"-14" | REPEAT OF 15"-19" | REPEAT OF 20"-27" | REPEAT OF 28"-36" |
|-------------------------|-----------------|------------------|-------------------|-------------------|-------------------|
| 54"                     | 0%              | 10%              | 15%               | 20%               | 25%               |
| 50" - 53"               | 16%             | 20%              | 25%               | 30%               | 35%               |
| 48"                     | 16%             | 25%              | 30%               | 35%               | 40%               |
| 45"                     | 40%             | 50%              | 55%               | 60%               | 65%               |
| 36"                     | 50%             | 60%              | 65%               | 70%               | 75%               |

Contact Integra Customer Service at 800-235-0234 x4 with any questions.

For graded-in fabrics, this additional fabric yardage will be noted and charged as a separate line on the quotation, sales order, and invoice.

## DESIGN AND SPECIFICATIONS (CONTINUED)

### CUSTOMER'S OWN MATERIAL (C.O.M.) POLICY:

Integra will work with customer's own material with approval. A memo sample of the fabric must be sent to the factory before the fabric can be approved for upholstery purposes only; this approval is NOT an indicator of how it will perform in the field. Following approval, you will be advised of any additional yardage which may be required for your order and any upcharges for special handling and/or hand cutting. COM combo yardage will increase yardage. Contact Customer Service for combo yardage summary. COM yardage estimates are based upon 54-inch wide textiles without pattern repeat. **COM must be on one continuous roll or the same dye lot and consistent repeat.** A memo sample of your fabric should accompany the purchase order to properly identify your fabric when it arrives at the factory.

Please note that all C.O.M. fabrics must ship freight prepaid (collect shipments will not be accepted) and should be properly labeled for your order. Ship to:

Integra, Inc.  
Tag for: (Your PO# of the order it is to be applied to)  
810 Wisconsin Street  
Walworth, WI 53184

The prices shown for COM include the product and only the labor for the fabric's application. The cost of fabric and freight costs to ship the fabric is the customer's responsibility. The performance of any fabric is the responsibility of the fabric supplier. Integra does not offer any warranty to fabrics. While we inspect fabrics for mill imperfections, some are difficult to recognize. We cannot be responsible for defects, color inaccuracies, dye lot variations, and other flaws. Under no circumstances will Integra assume responsibility for COM/COL shortages, flaws, or other such problems. While we make a concerted effort to control COM/COL materials, it is not our responsibility to monitor the receipt of these materials in order to meet delivery deadlines and we assume that customers are aware of any undue delay in delivery of their COM/COL materials.

**Integra does not warranty fabrics and is not responsible for any replacement fabric, covers, or re-upholstery labor costs for failed fabrics whether graded-in or sent to us as a COM/COL. We can provide a quote for new covers at the time needed. Please contact the fabric companies for any warranty information on their own products.**

### WOOD FINISHES AND WOOD SPECIES:

Integra cannot be responsible for differences in color or tone between the finish sample and final finished product. This difference is due to the variations in natural material and finish surface size.

Standard Wood Species: Hard Maple

### Original Wood Finishes

- Vanilla
- Ginger
- Cinnamon
- Nutmeg
- Saffron
- Chili
- Clove
- Pepper

### Inspired Colors Wood Finishes

- Sugar
- Sea Salt
- Almond
- Jasmine
- Pewter Mist
- Poppy Seed
- Hazelnut
- Mocha

### CUSTOM WOOD FINISH (CWF):

Integra will accept custom finish orders. This could extend lead time. There is a \$300 NET flat fee upcharge for custom finish orders. An additional upcharge is possible depending on stain. Paint finish will not be accepted. Send a wood sample which will be matched and returned to you for sign off approval. When the approval is received by Integra, the order will be entered into production. Custom wood finishes are valid for a minimum of 2 years.

### METAL POWDER COAT FINISHES:

- Glacier
- Chalk
- Cement
- Silver
- Fossil
- Bronze
- Bark
- Slate
- Onyx



## DESIGN AND SPECIFICATIONS (CONTINUED)

### LAMINATE:

On many Integra Tables, Table Arms, and Arm Caps, laminate is a top option. Please see each series for availability. Pricing for laminates falls into the following categories:

#### Stocked Laminates

Integra has chosen specific laminates to match our standard wood finishes where possible. Contact Customer Service for a list of standard laminates. See LAM Price in Price List.

#### Other Laminates

Any laminate not in our stocked program, including custom or premium, will incur a \$50 NET flat fee upcharge per laminate selection on each order. Orders with custom laminate or special finishes may have extended lead times.

### SOLID SURFACE:

Stocked Solid Surfaces: See current listing of Stocked Solid Surfaces

Non-Stocked Solid Surfaces: Upcharges will apply

### MOISTURE BARRIER:

A moisture barrier option is available for all styles of Integra seat units. A polyurethane layer is placed between the fabric and the foam to protect the foam from any moisture. There is an upcharge for this option; please see Product Options in each series for availability, current pricing and yardage requirements per item. Moisture Barrier may telegraph through thinner textiles.

### CALIFORNIA TB 117 AND 133 COMPLIANCE:

All Integra products with standard fabrics pass CA TB 117 fire code requirements, and are able to pass CA TB 133 using approved fabric and **fire wall**. Contact factory for information regarding approved fabrics which meet the requirements of this technical bulletin. Application of **fire wall** for TB 133 compliance requires an upcharge; see Product Options in each series for availability, current pricing and yardage requirements per item. We cannot be responsible for flame retardancy of C.O.M. fabrics; please consult published technical data of fabric suppliers. NOTE: CA TB 133 option not available with leather.

## PACKAGING & SHIPPING

### FREIGHT:

Shipments to AZ, NM, CA, OR, WA, ID, MT & NV over \$10,000 List include freight charges. Shipments to all other states within the Contiguous US over \$7,500 List include freight charges. Please note that cartoned shipments can incur additional expenses from our freight carriers. Please contact Integra Customer Service for upcharges.

Shipments made outside the Contiguous United States will be cartoned and shipped to the Port of Exit. Cartoning charges will apply; customer is responsible for freight charges from the Port of Exit to the final destination.

Integra's standard method is to set-up and blanket wrap furniture for shipping. This requires coordination with the freight company in order to meet and unload the truck at the destination. Furniture is assembled and will need to be inspected and set in place.

Integra will require receiving information at the time of the order and will advise estimated unloading time allotted for delivery. A loading dock to accommodate a 53' trailer is required for all shipments from Integra. Please note, improper loading dock at receiving point, lack of appropriate personnel to unload product and/or excessive unloading time will incur additional charges.

At time of delivery, blankets are removed and returned with driver. Inspection & damage must be noted within time allotted for unloading.

Should the freight company discover improper loading dock or inadequate personnel for unloading at time of delivery, the freight carrier reserves the right to have freight returned; this will incur reconsignment and reshipping charges which will be billed to the customer's account and will be due before the 2nd delivery attempt.

### SPECIFIC DATE DELIVERY:

If a shipment requires a specific day of delivery or time-specific delivery, additional charges will be applied by the freight company which will be added to your invoice. Shipments to New York City and Washington DC metro areas will also incur additional expenses from our freight carriers. Please contact Customer Service for upcharges.

### CARTON CHARGES:

In certain cases, and as an option, we can carton our furniture for shipping. The following cartoning charges will apply:

Carton Charges: \$35 NET per chair; \$50 NET per settee; \$65 NET per sofa. Tables: \$35 NET up to 24x24x24 in size; \$50 NET up to 36x36x36 in size and all oval, half oval and rectangular tables. 42x42 and 48x48 tables will be blanket-wrapped only; they cannot be cartoned. Please note that cartoned shipments can incur additional expenses from our freight carriers. Please contact Integra Customer Service for upcharges.

### MINIMUM ORDER FREIGHT CHARGE:

Shipments to AZ, NM, CA, OR, WA, ID, MT & NV under \$10,000 List will incur a \$500 NET Freight Charge. Shipments to all other states within the Contiguous US under \$7,500 List will incur a \$300 NET Freight Charge.

### FREIGHT DAMAGE CLAIMS:

All Integra products are carefully inspected prior to shipment from the factory. Title to products is passed to the purchaser and Integra's responsibility ceases when the shipment is accepted for transportation by a carrier. Freight claims are the responsibility of the customer. All shipments should be carefully inspected before acceptance and the customer MUST record any damage on both copies of the freight bill, signed by the customer and the driver. Concealed damage reports must be made to the carrier within 10 days after delivery or the carrier will not be responsible. All packing materials involved in a damage claim must be saved in their original condition until they have been inspected by the proper agent.

### STORAGE:

If a customer is unable to accept delivery of merchandise when Integra is ready to make a shipment, Integra reserves the right to transfer merchandise to storage. Transfer to storage and storage charges will be at customer's expense. Transfer to storage shall constitute delivery for all intents and purposes, including invoicing and payment.